



ATEX Zone 1 II B + T4

CSA/CUS Class 1 Div 1 Group C + D



Process Analyzer **User Manual**

P-840LT NO FLOW ANALYZER, LOW TEMP

FOREWORD

FOREWORD

Table of Contents	i
Warranty	v

INTRODUCTION - SECTION 1

Analyzer Overview	1-1
Principle of Operation	1-2
Component Identification	1-4
Front View	1-4
Control Enclosure	1-6
Measurement Enclosure	1-7
Menu Structure	1-8

SPECIFICATIONS - SECTION 2

Models	2-1
Performance	2-1
Sample Requirements	2-1
Signal Inputs/Outputs	2-2
Utility Requirements	2-2
Analyzer Enclosure	2-2

INSTALLATION AND STARTUP - SECTION 3

Site Requirements	3-1
Location	3-1
Mounting	3-1
Piping	3-4
Process Sample	3-8
Instrument Air	3-8
Cryocooler Coolant Supply	3-8
Optional Detection Cell Purge Gas Supply	3-8
Wiring	3-9
Electrical Power	3-9
Control Room Signals	3-10
Analog Output	3-10
Relay Output	3-10
Serial Output	3-10
Modbus	3-11
Digital Inputs	3-11
Startup	3-12



PROGRAMMING – SECTION 4

Main Run Screen	4-1
Menu Navigation	4-1
Advance Screen Key	4-2
Index Key	4-2
Enter Key	4-2
Up/Down Arrow Keys	4-2
Main Menu.....	4-2
Analyzer Status.....	4-2
Alarm History	4-2
Validation	4-3
Service.....	4-3
Setup	4-4
Setup Sub-Menu	4-5
Output Settings.....	4-5
4-20 Out 1 / 4-20 Out 2 / 4-20 Out 3	4-5
Digital Output	4-5
Trend Display	4-5
Alarm Settings	4-5
PP Alarm 1 / PP Alarm 2.....	4-6
No Detect	4-6
Other Settings.....	4-7
Reload Defaults.....	4-7
Stream Select.....	4-7
Come Read Time	4-7
Temperature Scale.....	4-7
Valid EV	4-7
Valid BW	4-8
Digital Inputs	4-8
Customer Alarm.....	4-8
Remote Standby.....	4-8
Stream Select	4-8
Validation	4-8
Screen Settings.....	4-8
Flush Heat.....	4-8
Cell Heat	4-8
Mode Settings	4-8
PP 1 Mode	4-8
PP 2 Mode	4-8
PP 1 Threshold.....	4-8
PP 2 Threshold.....	4-8
Cool Drag	4-8
Relay Setup.....	4-9
Relay.....	4-9
Choice.....	4-9
Conditions.....	4-9
State Table Setup.....	4-10



Time/Date Setup 4-10

Factory Setup 4-10

NORMAL OPERATION – SECTION 5

Main Run Screen 5-1

 Pour Point Analysis Results 5-1

 Date & Time 5-1

 Graphical Data Display 5-1

 Operational Status 5-2

 Message Line 5-2

Signal Outputs 5-3

 4-20 mA Analog Output 5-3

 Serial Output 5-3

 ModBus Output 5-3

Alarms 5-3

 Types of Alarm Conditions 5-3

 Alarm Warning 5-3

 Alarm Critical 5-3

 Come Read 5-3

 In Validation 5-3

 Validation 5-3

Alarms History 5-4

Taking the Analyzer Off-Line 5-5

 Locally 5-5

 Remotely 5-5

Performing a Validation Measurement 5-5

Switching Sample Streams 5-5

Loss of Power Restart 5-5

Internal Sample Leak 5-6

ROUTINE MAINTENANCE & SERVICE – SECTION 6

Recommended Routine Maintenance Schedule 6-1

Service & Operational Checks 6-1

 System Temperatures 6-2

 T1 6-2

 Sample 6-2

 Sensor 6-2

 Output Control 6-2

 Sample Solenoid 6-2

 Validation Solenoid 6-2

 Stream Solenoid 6-2

 4-20 Control 6-2

 Alarms 6-2

 Cell Temperature Control 6-2

 PWM Load 6-2

 Heater 6-2

 Cooler 6-3

 Pressure System 6-3



02-01-2013

Pressure 6.3
 DI 6-3

SPARE AND REPLACEMENT PARTS – SECTION 7

Spare Parts Kits 7-1
 1-Year Parts Kit 7-1
 2-Year Parts Kit 7-1
 Replacement Parts..... 7-2

DRAWINGS AND SCHEMATICS – SECTION 8



WARRANTY

POLICY

Orb Instruments warrants its products to the original purchaser against any defects that are due to faulty material or workmanship for a period of one year from date of shipment unless otherwise noted in the product manual.

In the event that a defect is discovered during the warranty period, Orb Instruments agrees that, at its option, it will repair or replace the defective product or refund the purchase price, excluding original shipping and handling charges. Any product repaired or replaced under this warranty will be warranted only for the remainder of the original product warranty period.

This warranty does not apply to consumable products such as chemical reagents, or consumable components of a product, such as, but not limited to, lamps and tubing.

Contact ORB Instruments or your distributor to initiate warranty support. Products may not be returned without authorization from ORB Instruments.

LIMITATIONS

This warranty does not cover:

- Damage caused by acts of God, natural disaster, labor unrest, acts of war (declared or undeclared), terrorism, civil strife or acts of any governmental jurisdiction.
- Damage caused by misuse, neglect, accident or improper application or installation.
- Any product not used in accordance with the instructions furnished by ORB Instruments.
- Freight charges to return merchandise to ORB Instruments.
- Freight charges on expedited or express shipment of warranted parts or product.
- Travel fees associated with on-site warranty repair.

This warranty contains the sole express warranty made by ORB Instruments in connection with its products. All implied warranties, including without limitation, the warranties of merchantability and fitness for a particular purpose, are expressly disclaimed.

Some states within the United States do not allow the disclaimer of implied warranties and if this is true in your state, the above limitations may not apply to you. This warranty gives you specific rights, and you may also have other rights that vary from state to state.

This warranty constitutes the final, complete, and exclusive statement of warranty/terms and no person is authorized to make any other warranties or representations on behalf of ORB Instruments.

LIMITATION OF REMEDIES

The remedies of repair, replacement or refund of purchase price as stated above are the exclusive remedies for the breach of this warranty. On the basis of strict liability or under any other legal theory, in no event shall ORB Instruments be liable for any incidental or consequential damages of any kind for breach of warranty or negligence.

ANALYZER OVERVIEW

The ORB Instruments' Model P-840LT Pour Point Analyzer is an on-line instrument designed for the continuous measurement of pour point in hydrocarbon refining processes. Extremely rugged and simple to operate, the compact P-840LT Pour Point Analyzer combines exceptional measurement accuracy with unmatched operational dependability to deliver highly reliable and repeatable pour point determinations day in, day out, month after month.

- Superior repeatability — $\pm 0.5^{\circ}\text{C}$ (1.0°F) or better.
- Exceptional uptime — 99% or better.
- -125° to $+25^{\circ}\text{C}$ (-193° to $+77^{\circ}\text{F}$) operating range.
- High pressure sample detection cell eliminates the need for atmospheric recovery.

For optimum installation and applications versatility, the P-840LT Pour Point Analyzer incorporates a wide variety of standard features, including:

- One isolated 4-20 mA analog output standard; two additional analog outputs available.
- Serial output.
- Three SPDT dry contact alarm relays.
- Optional ModBus output
- Separate control and measurement enclosures.
- NEC Class 1, Division 1, Group C, D or European ATEX Zone 1, Group IIB hazardous area classification.

PRINCIPLE OF OPERATION

The P-840LT Pour Point Analyzer is designed to provide pour point measurements in correlation with ASTM Method D-97 and IP-15. A precision differential pressure sensing system has been employed to monitor the loss of flow due to the formation of wax crystals during the measuring cycle cool down. The P-840LT's pressure sensor monitors the state of flow conditions through a high-pressure detection cell that allows measurements to be performed at process pressures, eliminating the need for atmospheric sample recovery. A state-of-the-art air- or water-cooled cryocooler provides cooling power to the detection cell down to -125°C (-193°F). The use of the cryocooler eliminates the requirement of an external, explosion-proof re-circulating chiller system.

See Figures 1-1a and 1-1b.

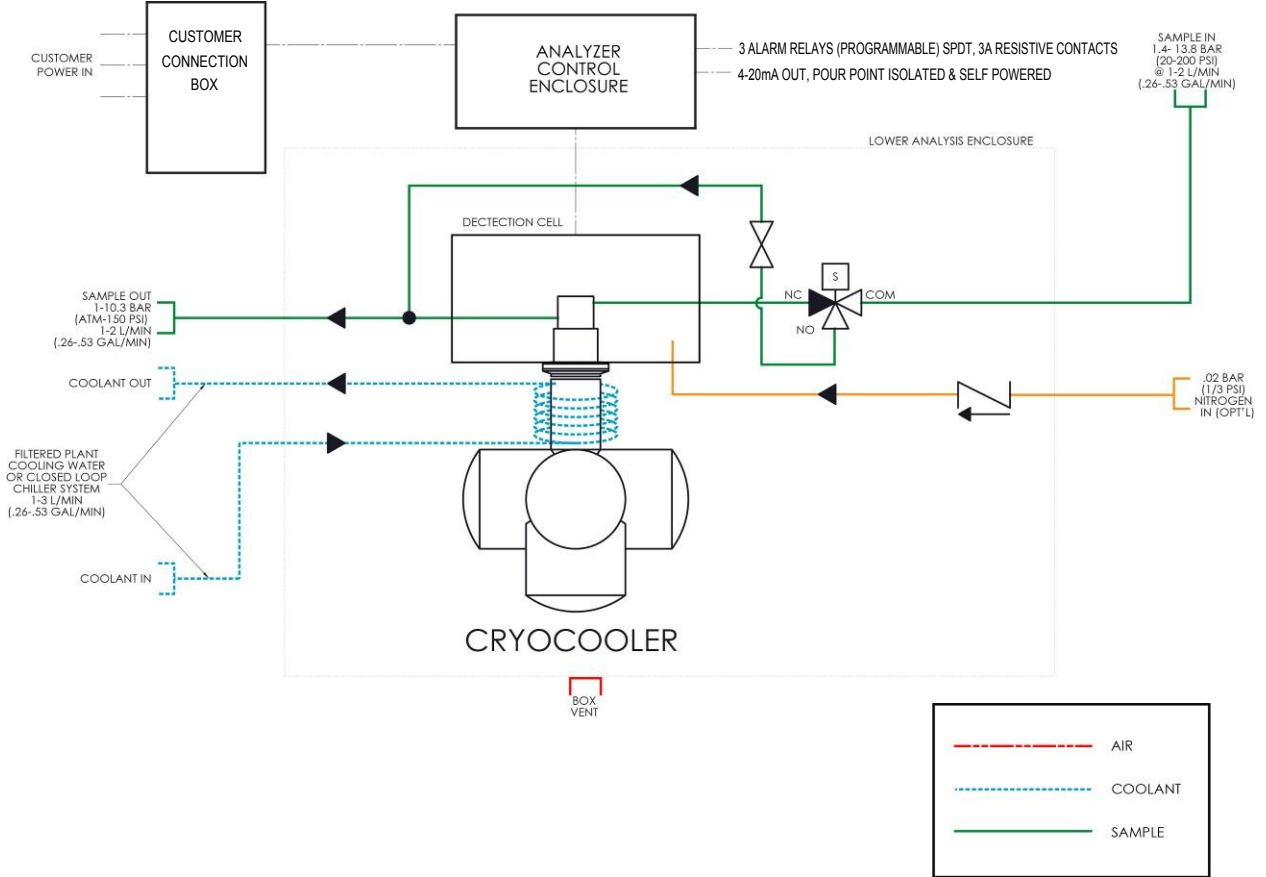

**Figure 1-1a: Flow Schematic
(Analyzers with a Water-Cooled Cryocooler)**

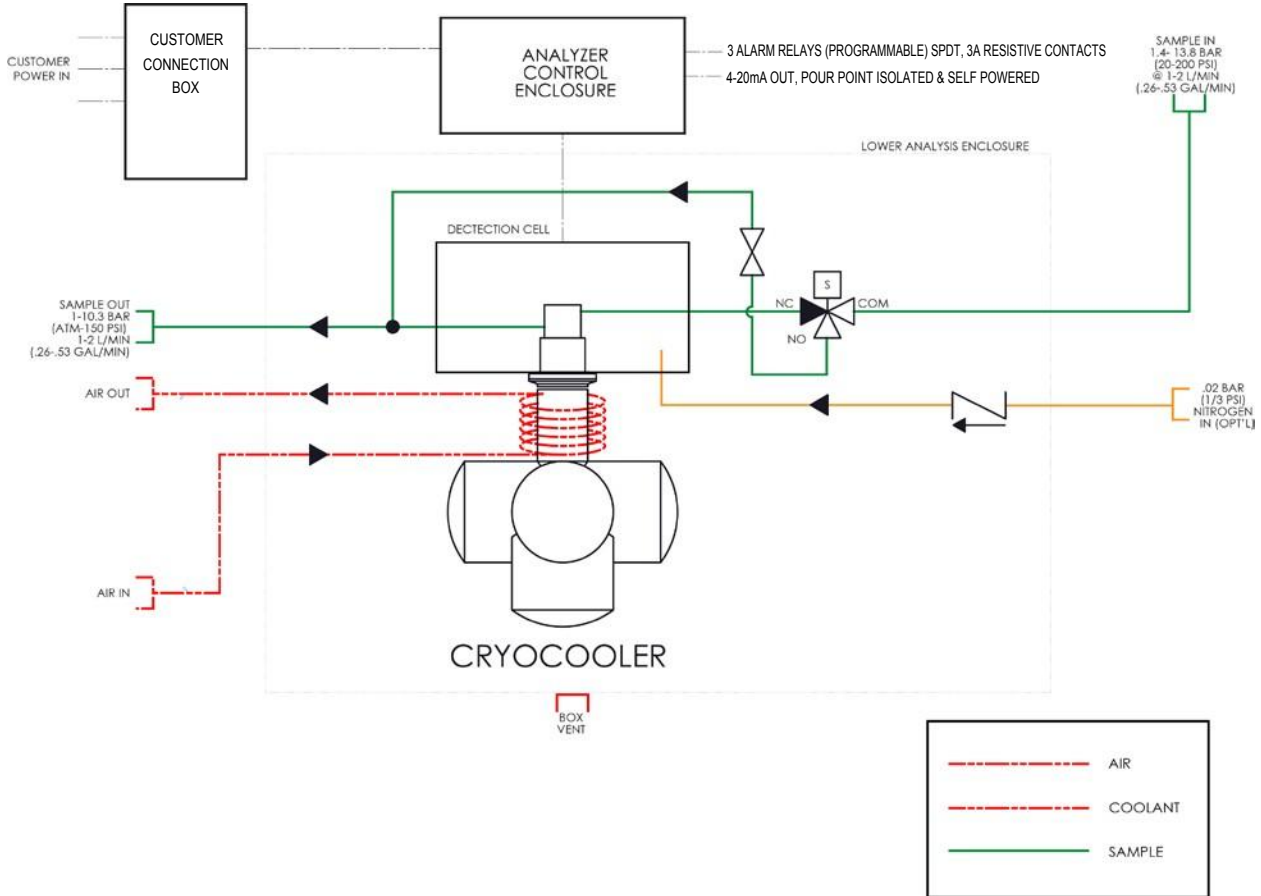

**Figure 1-1b: Flow Schematic
(Analyzers with an Air-Cooled Cryocooler)**

A typical measurement cycle takes between 10 and 45 minutes and is performed as follows:

1. The sample solenoid opens and fresh sample is flushed through the detection cell to warm and dislodge any wax crystals which may have remained from the previous measurement. The duration of the flush cycle is user-programmable.
2. The sample solenoid closes, locking fresh sample in the detection cell.
3. The cryocooler is activated. The power applied to the cryocooler is programmable, continuously monitored, and automatically adjusted to maintain consistent cooling times to pour point detection.
4. While the sample cools, both the sample temperature and the signal from the pressure transducer are monitored. The temperature at which the differential pressure in the detection cell changes is the pour point.
5. When pour point is detected, the temperature is displayed locally and output as an analog and/or serial signal.
6. The sample solenoid opens and a new measurement cycle is initiated.

COMPONENT IDENTIFICATION

FRONT VIEW

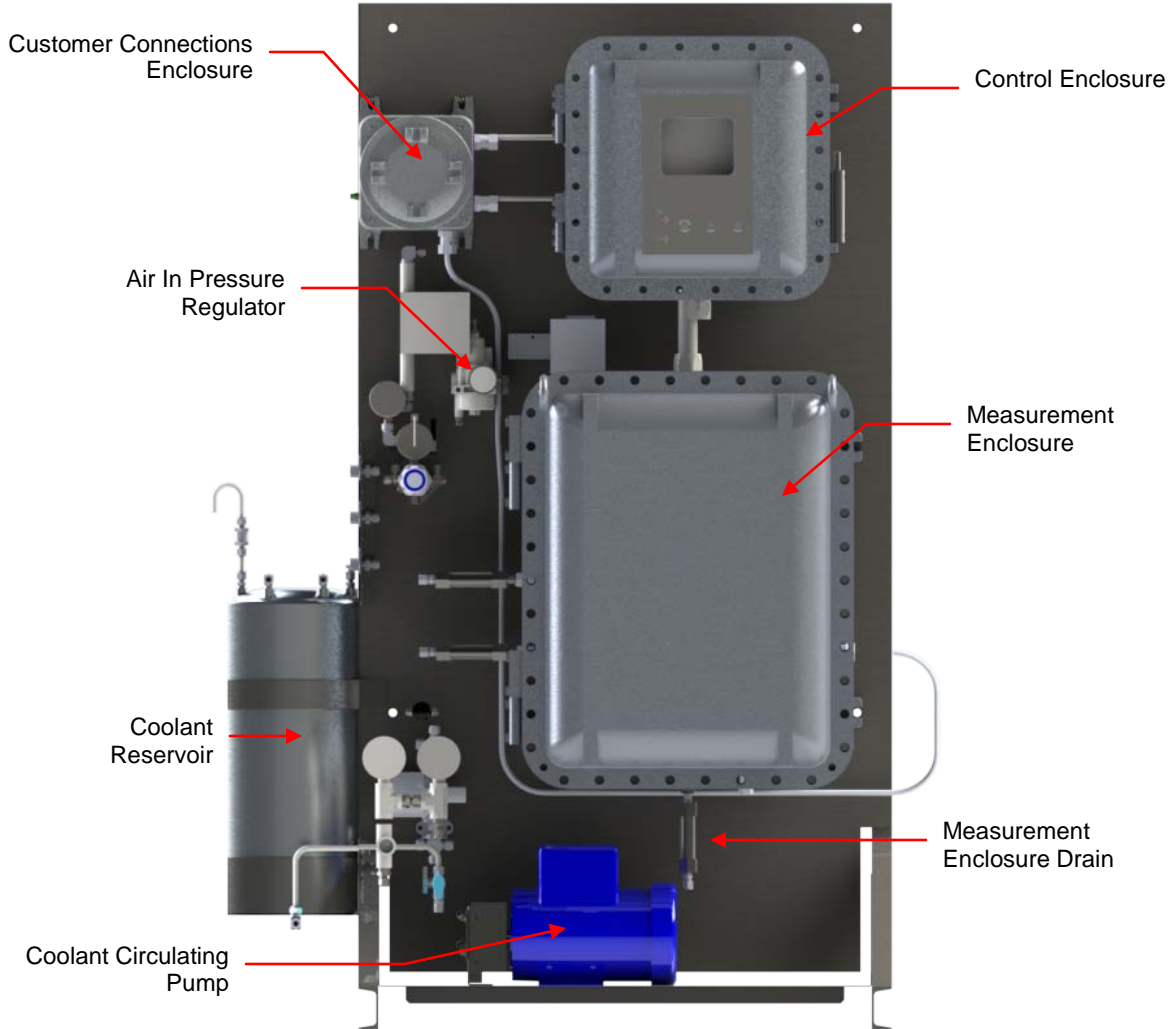

**Figure 1-2a: Front View
(Analyzers with a Water-Cooled Cryocooler)**

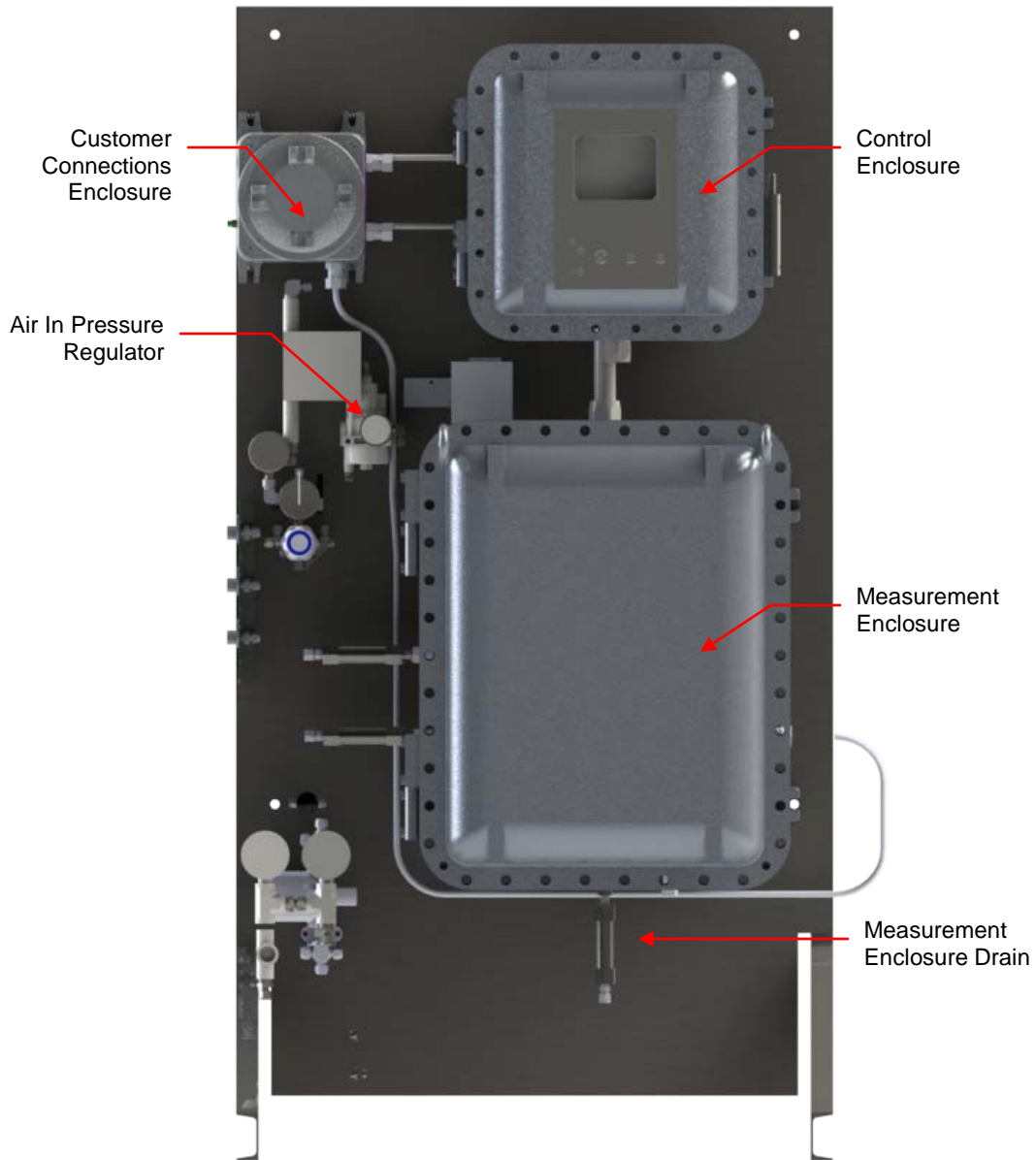

**Figure 1-2b: Front View
(Analyzers with an Air-Cooled Cryocooler)**

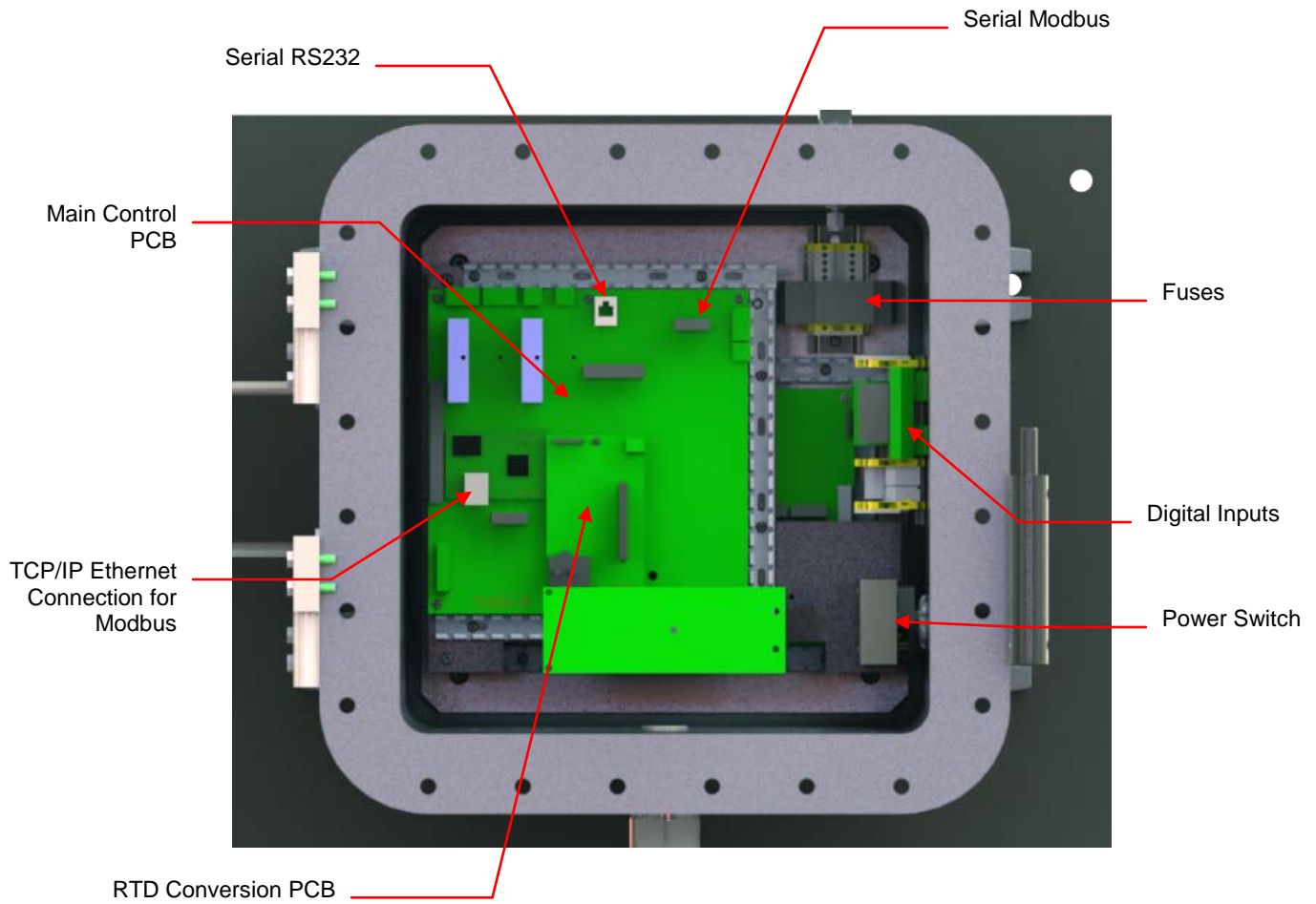

Figure 1-3: Control Enclosure

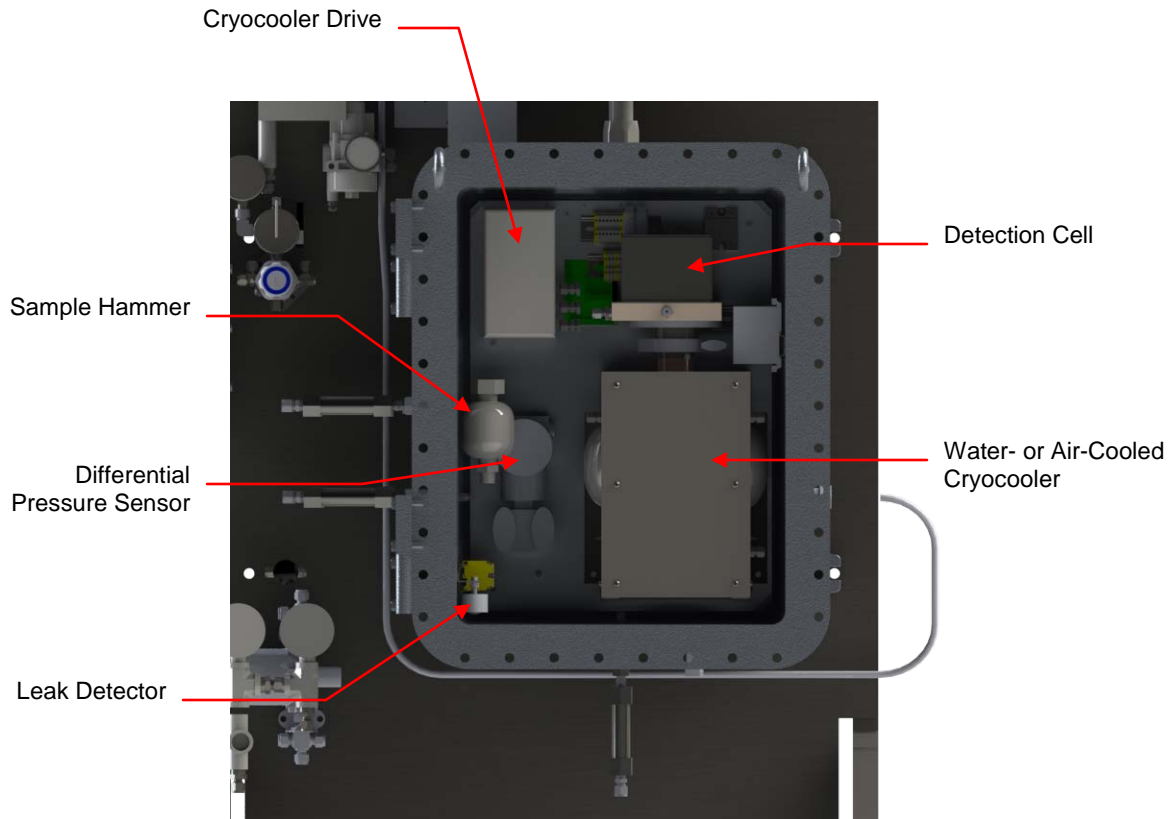

Figure 1-4: Measurement Enclosure

MENU STRUCTURE

Main Menu	Sub-Menu	Items	Choices / Settings / Comments
Analyzer Status	—	—	On Line / Off Line
Alarm History	—	—	Display only
Validation	—	Validate	Digital / Auto
Service	—	Sys Temperatures T1 Sample Sensor Output Control Sample Solenoid Validation Solenoid Stream Solenoid 4-20 Control 4-20 1 4-20 2 4-20 3 Alarms R1 R2 R3 Cell Temp Control PWM Load Heater Cooler Pressure System Pressure DI	For future use Display only – sample temperature Display only – pressure On / Off On / Off On / Off Outputs analog signal for device calibration Outputs analog signal for device calibration Outputs analog signal for device calibration On / Off On / Off On / Off Display only On / Off On / Off Display only Display only – status of digital inputs

Main Menu	Sub-Menu	Items	Choices / Settings / Comments
Setup	Output Settings	4-20 Out 1 4-20 Out 2 4-20 Out 3 Digital Output Trend Display Mode Type Enabled/Disabled Low High Clear Graph	4 mA value / 20 mA value / offset 4 mA value / 20 mA value / offset 4 mA value / 20 mA value / offset RS232N / RS232D Live / History Display only Enables or disables graphing Sets bottom of trend graph scale Sets top of trend graph scale Clears graph
	Alarm Settings	PP Alarm 1 Low High PP Alarm 2 Low High No Detect Time Cycle	Stream 1 pour point alarm Lowest allowable pour point Highest allowable pour point Stream 2 pour point alarm Lowest allowable pour point Highest allowable pour point Maximum allowable time to detect pour point Maximum number of cycles to detect pour point
	Other Settings	Reload Defaults Standby Mode Stream Select Come Read Time Temperature Scale Valid EV Valid BW Digital Inputs Screen Settings Flush Heat Cell Heat Mode Settings PP1 Mode PP2 Mode PP 1 Threshold PP 2 Threshold Cool Drag Relay Setup Relay Choice Conditions	Restores factory settings On / Off Stream 1 / Stream 2 / Alternate / Auto Select User selected in seconds °C / °F Expected pour point Allowable deviation from expected pour point Customer Alarm / Remote Standby / Stream Select / Validation Intensity / Screen Saver % power applied to heater during flush step % power applied to heater during cell heating Detection mode for Stream 1 Detection mode for Stream 2 Pour point sensitivity setting for Stream 1 Pour point sensitivity setting for Stream 2 % power to heater to retard cryocooler cooling R1 / R2 / R3 Off / Alarm Warning / Alarm Critical / Come Read / In Validation / Validation Normal / Failsafe
	State Table Setup	—	Steps in measurement cycle
	Time/Date Setup	Time Format Date Format Date Time	12 hour / 24 hour) US / EU MM/DD/YY or DD/MM/YR HH/MM/SS
	Factory Setup	—	For factory use only
Security	—	—	Enable / Disable



02-01-2013

[THIS PAGE INTENTIONALLY BLANK]



MODELS

P-840LT-1400	For NEC Class I Division 1 Group C, D Hazardous Areas
P-840LT-1500	For ATEX Ex d IIB Hazardous Areas

PERFORMANCE

Measurement Range	Minimum: -125°C (-193°F) Maximum: +25°C (+77°F)
Repeatability	±0.5°C (1.0°F)
Reproducibility	Meets or exceeds ASTM Method D-97 or IP-15
Resolution	±0.25°C (0.5°F)
Measurement Accuracy	Meets or exceeds ASTM Methods D-97 or IP-15
Temperature Accuracy	±0.5°C (±1.0°F)
Measurement Cycle Time	10 to 45 minutes
Operating Temperature Range	Minimum: 5°C (40°F) Maximum: 40°C (105°F)

SAMPLE REQUIREMENTS

Sample Flow Rate	Minimum: 1 liter/minute Maximum: 2 liters/minute
Sample Return Pressure	Atmospheric to 10 bar (150 psi) maximum
Sample Pressure	Minimum: 1.4 bar (20 psi) Maximum: 14 bar (200 psi)
Sample Temperature	Minimum: 2°C (35°F) Maximum: 100°C (212°F)
Sample Particulates	Less than 10 µm; optional sample conditioning system available
Sample Conditions	Homogeneous, single-phase sample. Must be free of water or water moisture

SIGNAL INPUTS/OUTPUTS

Analog Output	One isolated 4-20 mA outputs standard; optional two additional isolated 4-20 mA outputs available. Signal output information is programmable.
Serial Communication	RS232 (RS485 optional)
Relay Output	Three SPDT failsafe relay contacts rated at 3A resistive load at 250 VAC. May be programmed for normal or failsafe operation. The conditions activating these relays are programmable.
ModBus	Optional; consult ORB Instruments

UTILITY REQUIREMENTS

Power	Auto-selecting 100 to 125 VAC ($\pm 10\%$) and 200 to 240 VAC ($\pm 10\%$), 50/60 Hz, single phase, 10A.
Optional Detection Cell Purge Gas Supply	Clean, dry nitrogen (better than 98% pure) or other inert gas at 0.07 bar (1.0 psi).
Instrument Air	<u>Analyzers with Water-Cooled Cryocooler</u> (for sample solenoid): Clean, dry instrument air at a minimum of 4 bar (58 psi). <u>Analyzers with Air-Cooled Cryocooler</u> (for sample solenoid and cryocooler): Clean, dry instrument air at 6-8 bar (87-116 psi); 50 cfm consumption.
Cryocooler Coolant	<u>Analyzers with Water-Cooled Cryocooler only:</u> Clean, filtered plant cooling water or closed-loop chiller system. Fluid Temperature: Up to 35°C (95°F); Flow rate: 2-4 liters/minute (0.5-1.0 gpm); Pressure: 2 bar (30 psi) minimum.

ANALYZER ENCLOSURE

Dimensions (W x H x D)	<u>Analyzers with Water-Cooled Cryocooler:</u> 1187 x 1803 x 660 mm (46.75 x 71.0 x 26.0 inches) <u>Analyzers with Air-Cooled Cryocooler:</u> 935 x 1803 x 559 mm (36.75 x 71.0 x 22.0 inches)
Weight	Approximately 270 kg (600 pounds)
Enclosure Rating	NEMA 4X / IP65 rated EExd enclosures
Certification	CE certified
Hazardous Classification	Model dependent; see above.

	<p>WARNING: Installation or operation of this Analyzer outside of the parameters indicated in the Specifications could result in personal injury or damage to the Analyzer. Installation, operation, and maintenance should be performed only by fully qualified personnel.</p>
---	--

SITE REQUIREMENTS

Your particular site, application, and installed options will ultimately determine the need for any accessories or auxiliary equipment. This section defines the various parameters to be considered. Consult ORB Instruments for specific recommendations regarding your P-840LT Pour Point Analyzer.

LOCATION

For ease of operation, your Analyzer should be installed as close as possible to the process stream to be monitored. To optimize performance, it should be housed in an appropriate shelter and protected against direct sunlight, moisture, and other adverse conditions. The shelter's ambient temperature should remain between 5° and 40°C (40° and 105°F) at all times.

MOUNTING

	<p>NOTE: An optional free-standing mounting rack is standard.</p>
--	--

The P-840LT Pour Point Analyzer is either frame or shelter mounted and should be installed on a flat, level surface free from intense vibration. Frame legs or shelter feet are designed for use with ½ inch expansion bolts. See the Drawings section of this manual for exact system dimensions. When placing the system, care should be taken to ensure that all sides of the system are easily accessible and that ample space is provided for regular system maintenance.

The bottom of the enclosure should be located approximately 12 inches (30.5 cm) above the floor of the shelter. Adequate clearance (approximately 12 inches/30.5 cm) should also be allowed on either side of the unit for sample, utility, and control room connections.

See Figures 3-1a and 3-1b.

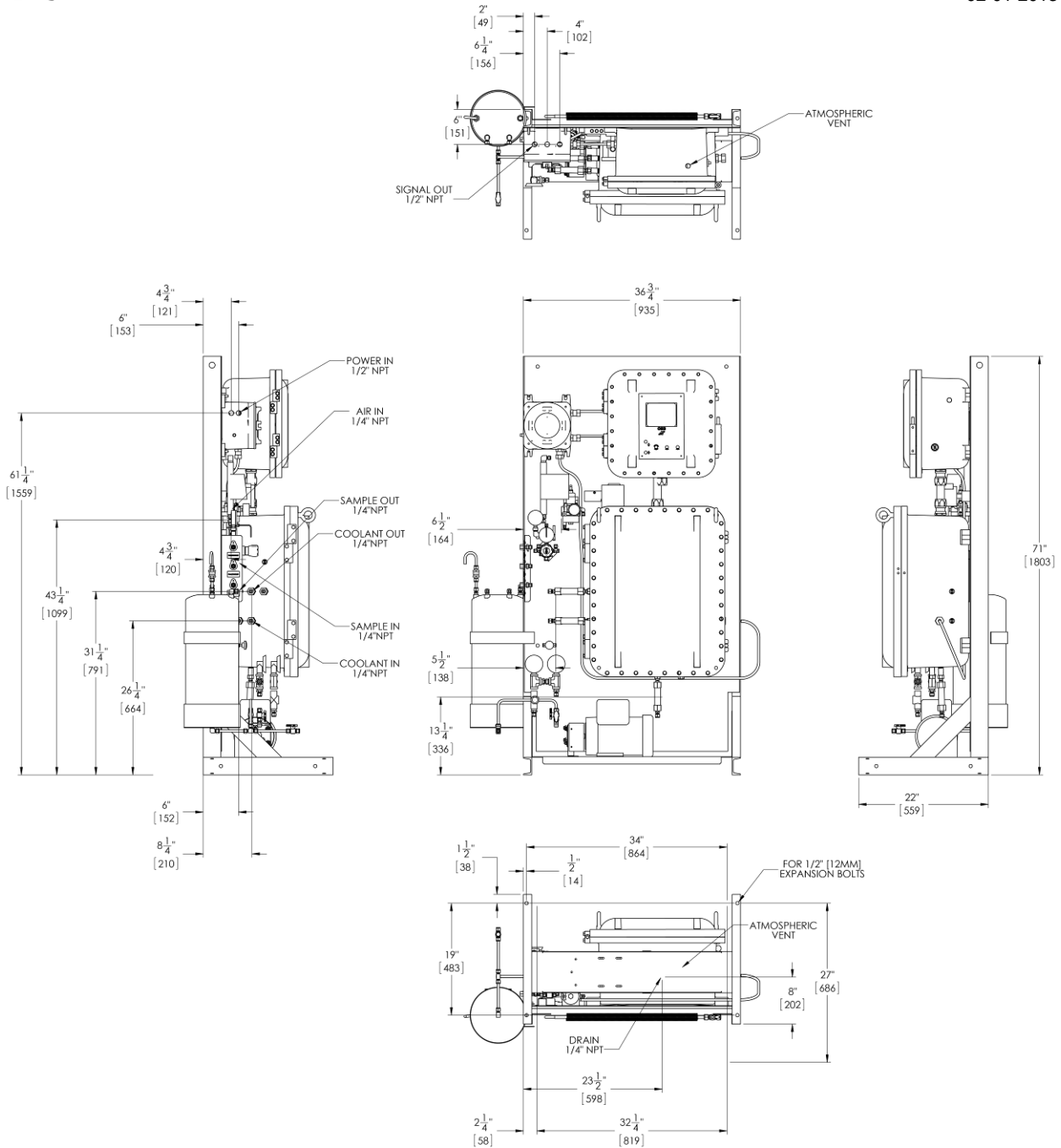

**Figure 3-1a: Dimensional Drawing
(Analyzers with a Water-Cooled Cryocooler)**

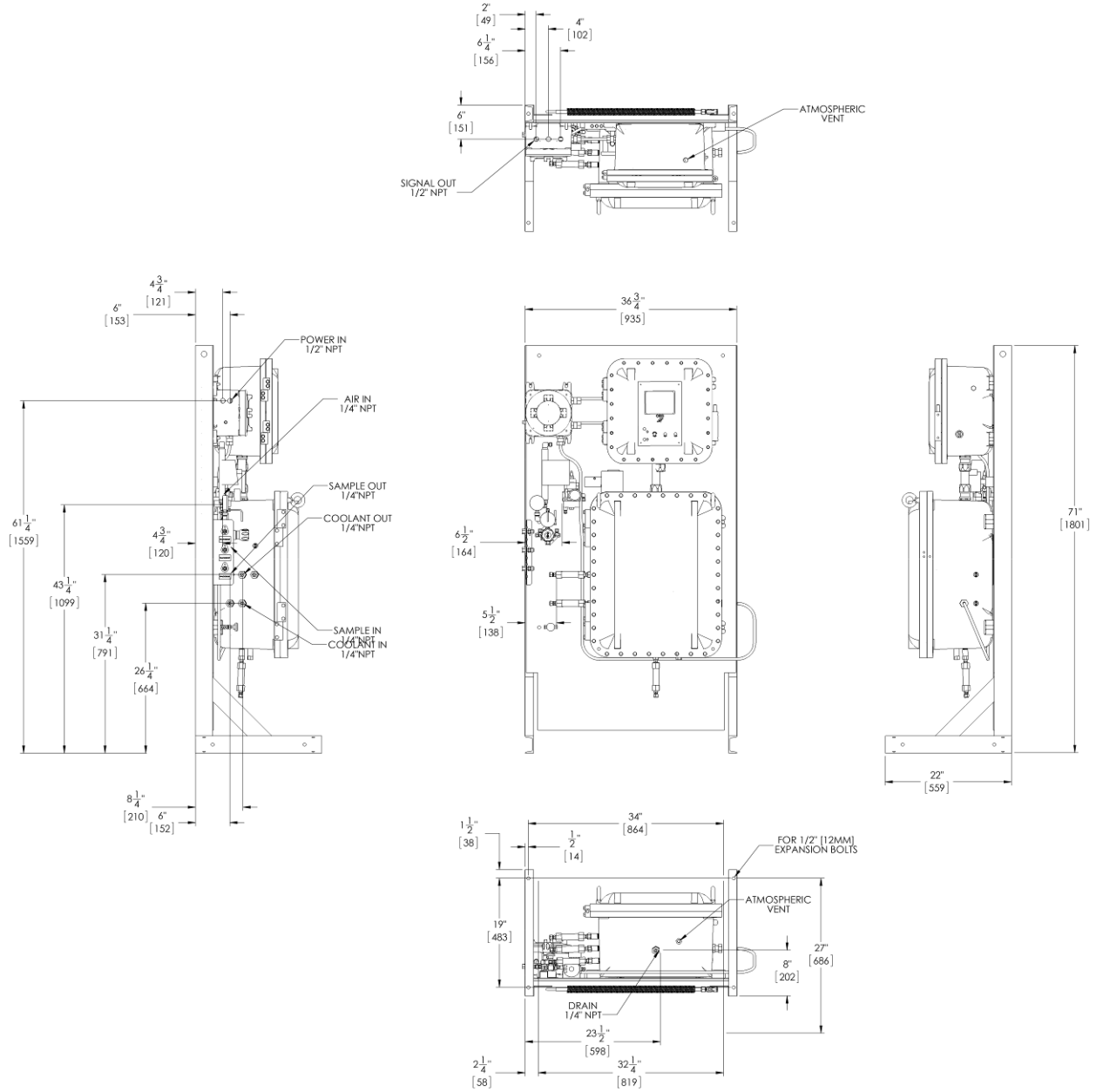
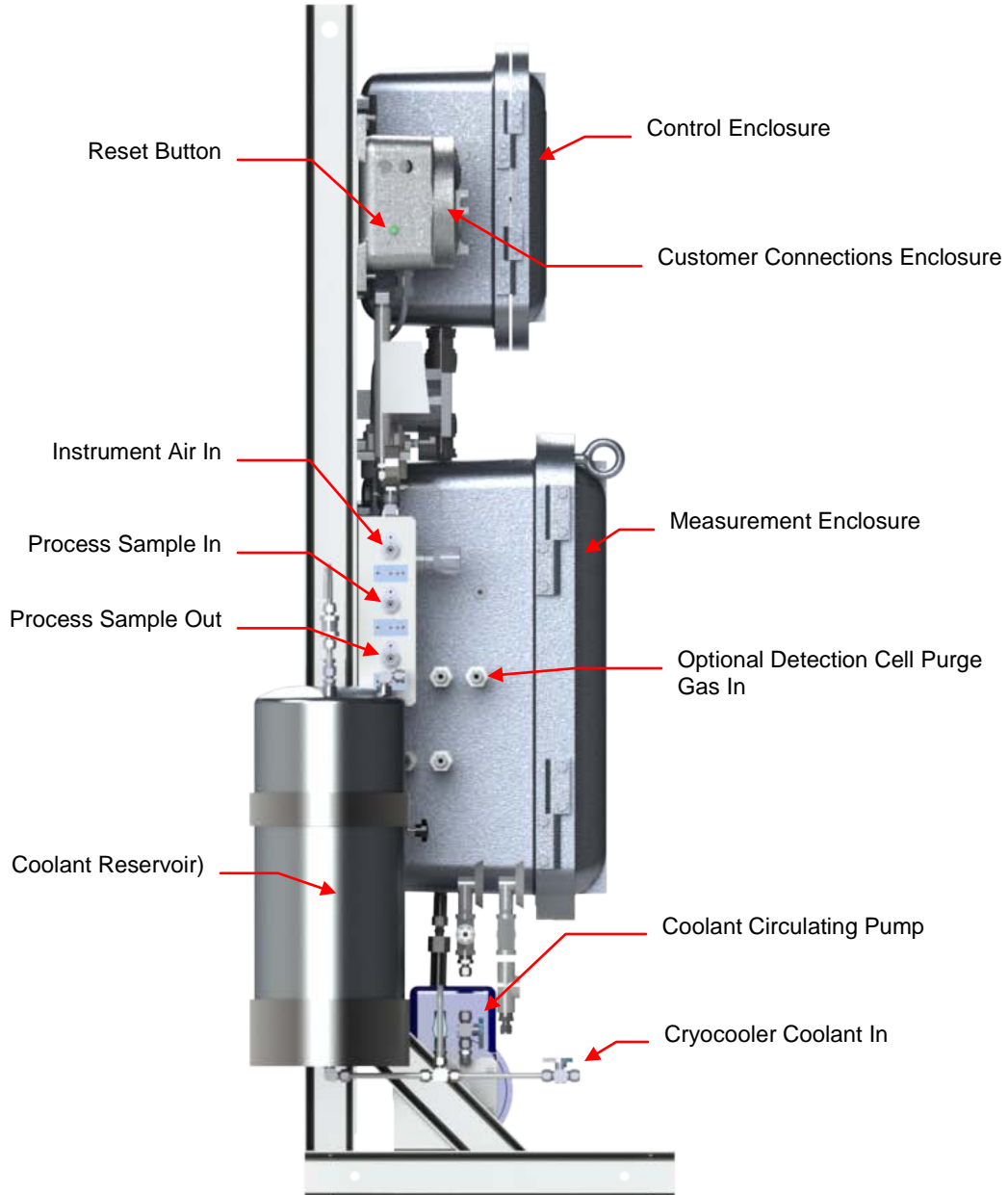

**Figure 3-1b: Dimensional Drawing
(Analyzers with an Air-Cooled Cryocooler)**

PIPING

The P-840LT Pour Point Analyzer incorporates fittings for connecting process sample, instrument air, and optional detection cell purge gas. Analyzers with a water-cooled cryocooler also have connections for plant cooling water. These fittings are located on the sides of the instrument.

See Figures 3-2 and 3-3.



**Figure 3-2a: Left Side View
(Analyzers with a Water-Cooled Cryocooler)**

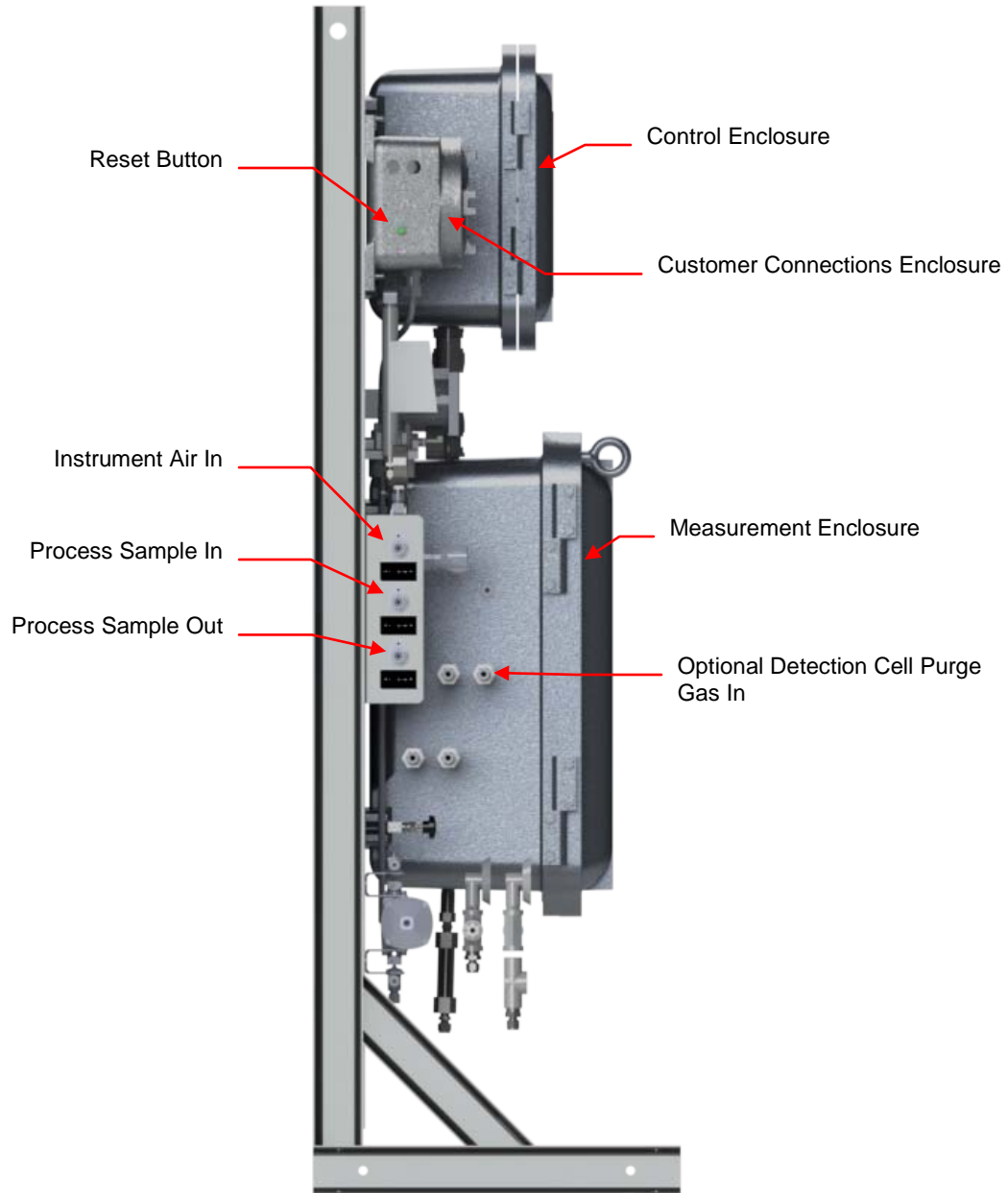
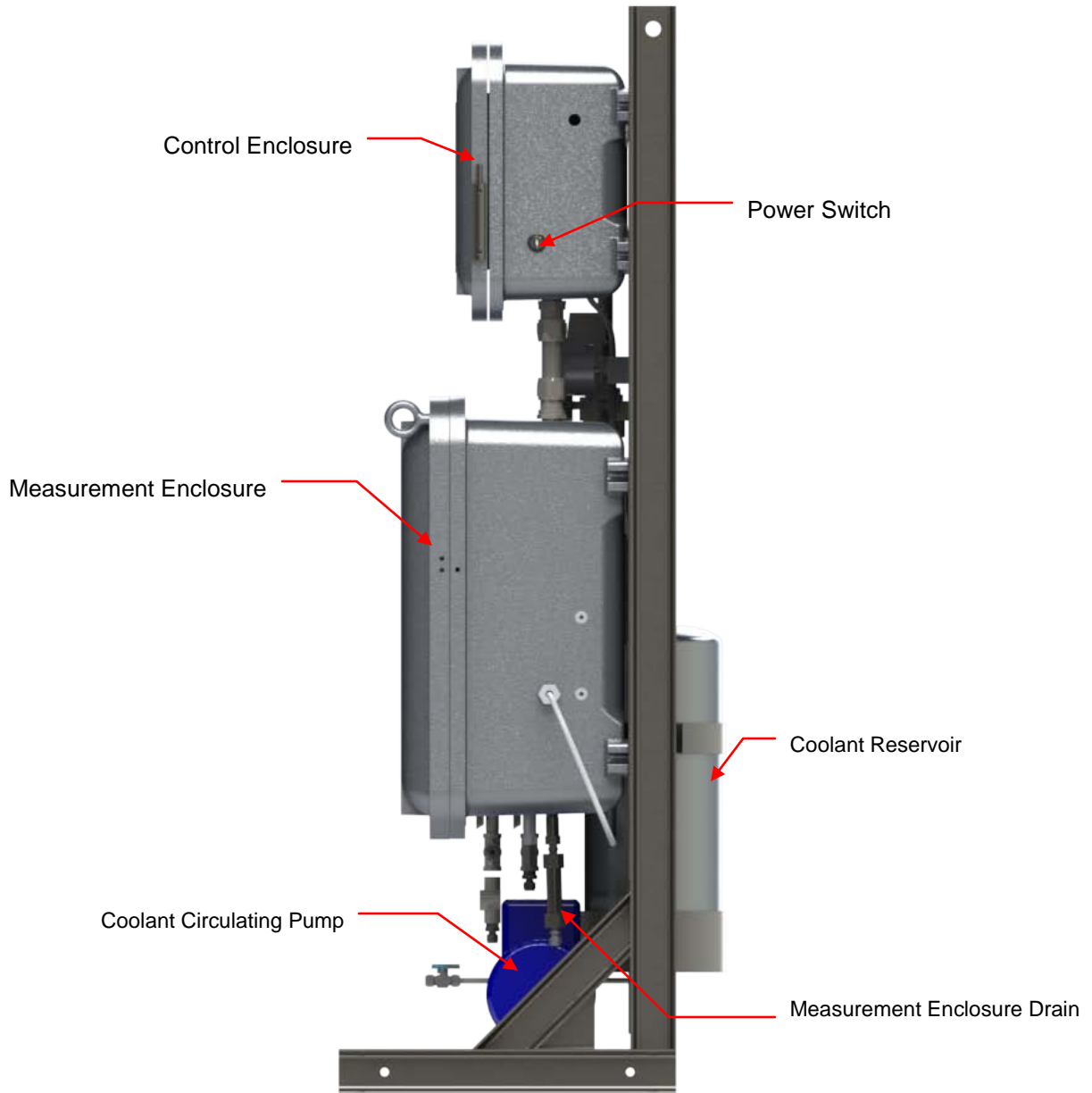
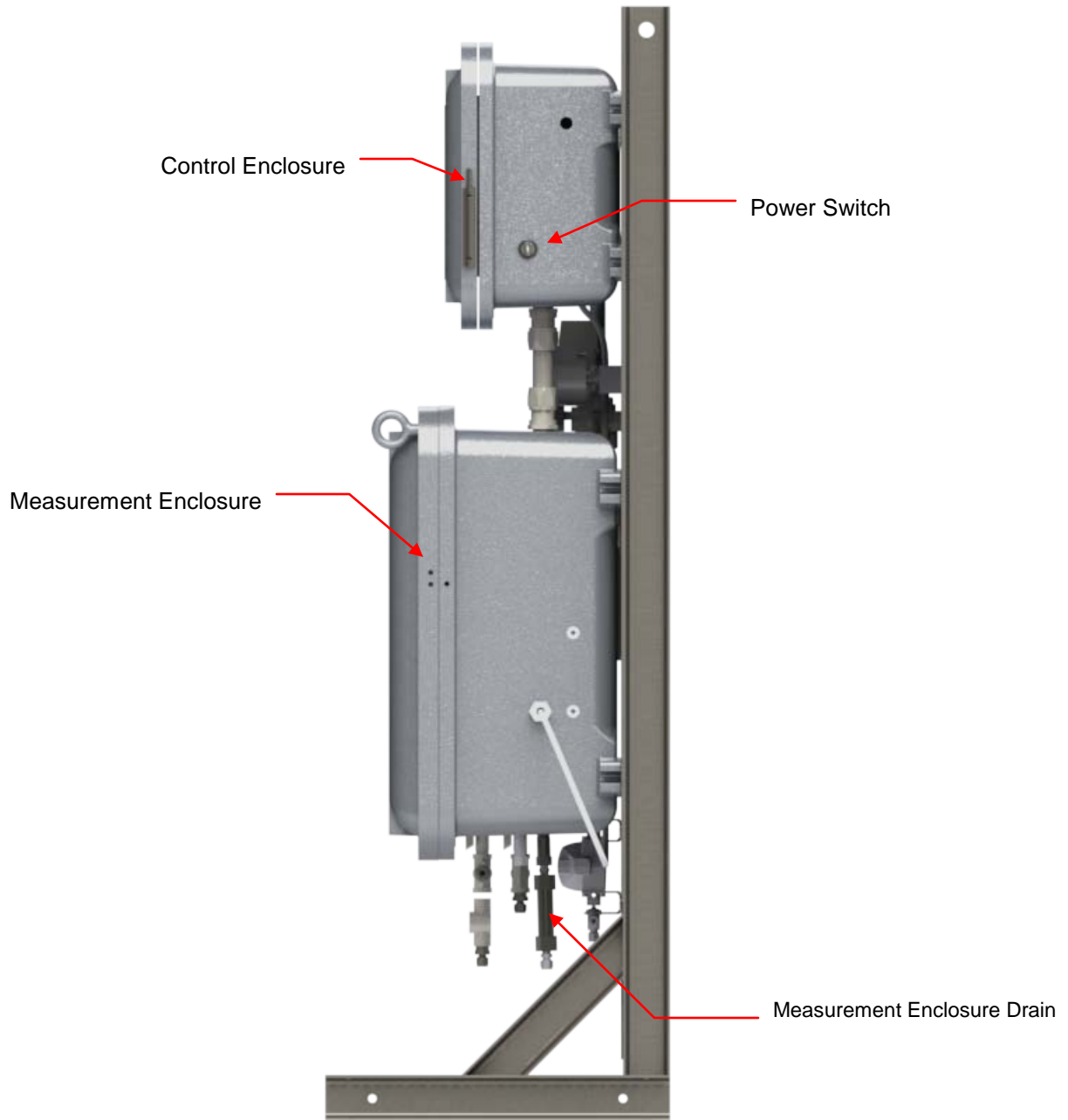

Figure 3-2b: Left Side View
(Analyzers with an Air-Cooled Cryocooler)



**Figure 3-3a: Right Side View
(Analyzers with a Water-Cooled Cryocooler)**



**Figure 3-3b: Right Side View
(Analyzers with an Air-Cooled Cryocooler)**

PROCESS SAMPLE



NOTE: It is the user's responsibility to assure that a representative sample, free of moisture and particulate matter, is presented to the instrument for analysis. ORB Instruments can assist in specifying sample conditioning requirements and the selection/development of an appropriate sample conditioning system.

Process sample lines are connected to the 1/8 inch NPT fittings located on the left side of the lower enclosure (Figures 3-2a and 3-2b). Process samples should be provided at a pressure between 1.4 and 14 bar (20 and 200 psi) at a flow rate of 1 to 2 liters/minute. The temperature of the sample should be between 2° and 65°C (35° and 150°F).

INSTRUMENT AIR

Analyzers with a water-cooled cryocooler: Clean, dry Instrument air at a minimum pressure of 4 bar (58 psi) is required to operate the sample solenoid. This connection is made on the right side of the Analyzer (Figure 3-2a).

Analyzers with an air-cooled cryocooler: Clean, dry Instrument air at a pressure of 6 to 8 bar (87 to 116 psi) is required to operate the sample solenoid and provide cooling air to the Vortex cooler. The instrument air supply should be capable of delivering at least 50 cfm. This connection is made on the right side of the Analyzer (Figure 3-2b).

CRYOCOOLER COOLANT SUPPLY

Analyzers with a water-cooled cryocooler only: Clean, filtered plant cooling water (or a closed loop chiller system) is required for cooling of the Analyzer's cryocooler. Cooling water should be supplied at a temperature below 35°C (95°F) at a flow rate of 2 to 4 liters/minute (0.5 to 1.0 gpm) and a pressure of at least 2 bar (30 psi). The detection cell cooling supply connection is made on the lower right side of the measurement enclosure (Figure 3-2a).

OPTIONAL DETECTION CELL PURGE GAS SUPPLY

The P-840LT Pour Point Analyzer's provides for an optional inert gas purge to prevent condensation from forming on the cryocooler. This optional purge, if supplied, requires clean, dry nitrogen (98% pure) or other inert gas at a pressure of 0.7 bar (1.0 psi); This insert gas connection is made on the left side of Measurement Enclosure (Figures 3-2a and 3-2b).

WIRING

ELECTRICAL POWER

	<p>WARNING: This Analyzer is designed to meet the requirements of either the National Electrical Code (NEC) for installation in Class I, Division 1, Group C and D or European ATEX Zone 1, Group IIB hazardous areas. It is the user's responsibility to complete the electrical connections and comply with all pertinent codes.</p>
---	---

	<p>WARNING: All electrical connections should be made by a licensed, qualified electrician. Proper building codes and safety regulations should be followed.</p>
---	---

The P-840LT Pour Point Analyzer requires an independent 100 to 240 VAC ($\pm 10\%$), 50/60 Hz. power supply. AC power connections are made through the Customer Connections box attached to the upper left of the top enclosure (Figures 3-2a and 3-2b).

	<p>CAUTION: It is the installer's responsibility to verify that the jumpers on JP1 are configured properly for the supply voltage.</p>
---	---

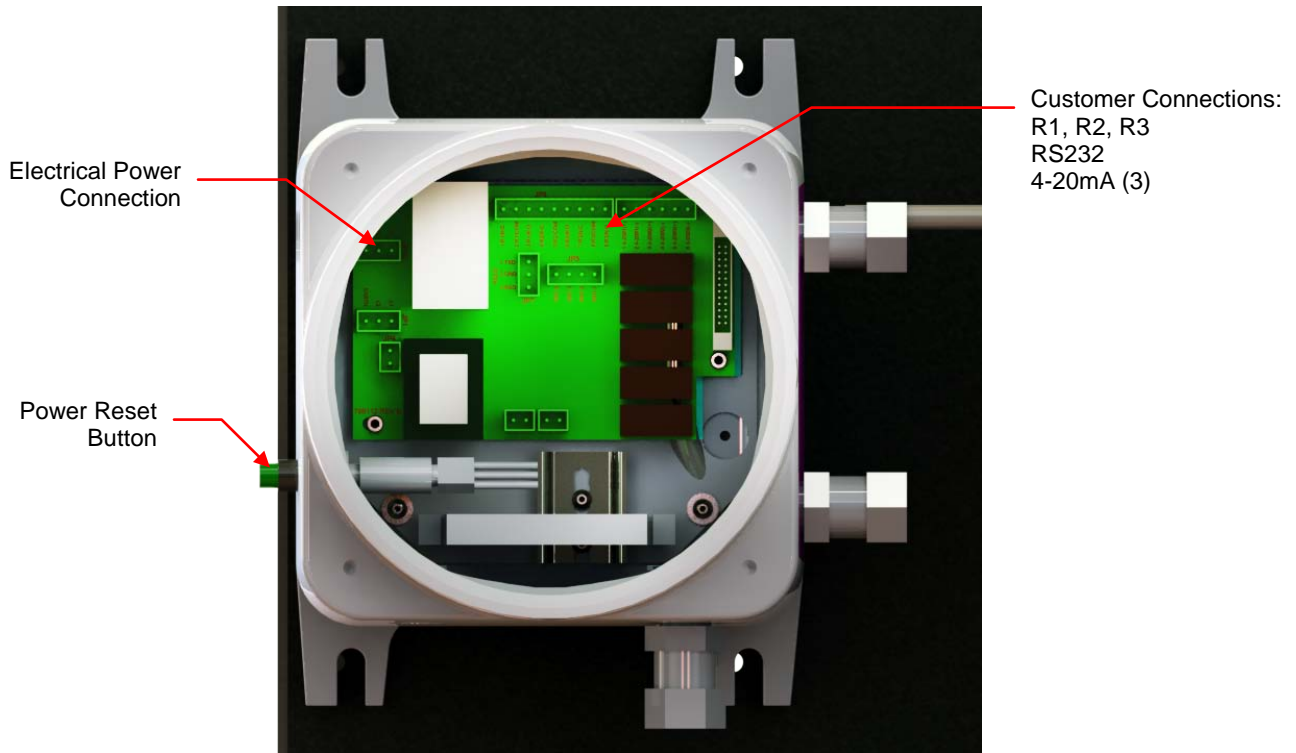

Figure 3-4: Customer Connections Enclosure

The P-840LT-1500 Pour Point Analyzer has internal and external grounding harnesses that tie all enclosures and power distribution together to a grounding lug mounted to the Analyzer frame leg. The grounding wire is 10 gauge with a green/yellow spiral Teflon[®] insulation and a 36 x 26 strand. Customer earth connection is made at this point (Figure 3-5).

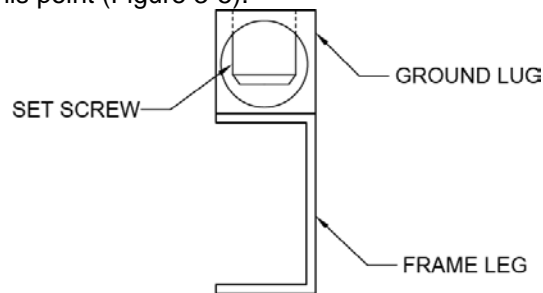

Figure 3-5: Customer Earth Connection

CONTROL ROOM SIGNALS

The Analyzer incorporates analog, serial, and relay output capability. ModBus output may be provided as a factory installed option.

The connections for control room signals are made in either the Customer Connections Enclosure (Figure 3-4) or the Control Enclosure (Figure 3-6).

Analog Output

One isolated 4-20 mA output is standard on the P-840LT Pour Point Analyzer. An optional two additional 4-20 mA outputs may be provided. These connections are made in the Customer Connections Enclosure (Figure 3-4). See Section 4 for information on setting the 4-20mA parameters.

Relay Output

The Analyzer incorporates three SPDT relay contacts rated at 3A resistive load at 250 VAC. The relays may be programmed for either normal (non-energized) or failsafe (energized) operation and used to signal a variety of operational conditions. These connections are made in the Customer Connections Enclosure (Figure 3-4). See Section 4 for information on alarm programming.

Serial Output

[The P-840LT Pour Point Analyzer incorporates RS232 serial output. The maximum allowable external cable length on the RS232 output 98 feet is (30 meters). This connection is made in the Control (Figure 3-6). RS485 serial output is available as an option and requires an auxiliary communications module (consult factory).

Serial communication operates at 9600 baud, no parity, 8 start bits, 1 stop bit. Data is comma delimited and output in the following sequence:

Date (mm/dd/yy)
Time (hr/min/sec)
Pour point value (XX.XX°)

A <CR> is used to designate the end of the data stream.

ModBus

ModBus is available as a factory-installed option which utilizes either the Analyzer’s TCP/IP connection for ModBus or its serial ModBus connection. This connection is made in the Control Enclosure (Figure 3-6). Consult ORB Instruments for more information.

Digital Inputs

The Analyzer incorporates four sets of voltage dry contacts that allow the control room to remotely activate selected functions. The connections for these digital inputs are made inside the Control Enclosure (Figure 3-6).

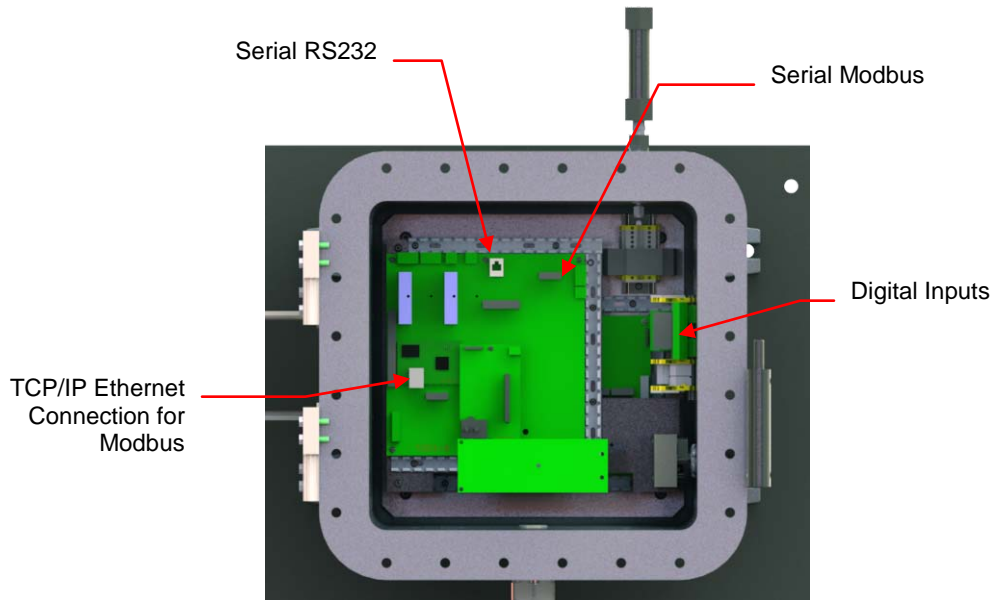

Figure 3-6: Control Enclosure

Customer Alarm — This connection is used to activate one or more of the Analyzer’s alarm relays when an external dry contact alarm signal is received.

Remote Standby — This connection is used to place the Analyzer in a standby mode whenever an external dry contact signal is received. Analysis will stop until the signal is removed.

Validation Request — This connection is used to initiate a validation cycle whenever an external dry contact signal is received. The instrument will finish the current measurement cycle and then hold the resulting 4-20 mA output signals until the validation cycle has been completed.

Stream Select — This connection is used to switch to a different sample stream whenever an external dry contact signal is received. Sample stream selection is made by opening/closing this contact.

Digital Input	Terminals	Function
D0	1-2	Customer alarm
D1	3-4	Remote standby
D2	5-6	Validation
D3	7-8	Stream select
D4-7	9-16	Reserved for future use



NOTE: Although the Validation Request and Stream Select contacts may be present, these functions are only available on Analyzer's which incorporate these options.

STARTUP

1. Start flow of process sample to the Analyzer and verify that the flow rate is between 1 and 2 liters/minute. Check for sample line leaks.
2. Analyzers with an air-cooled cryocooler only. Verify that the Vortex valve is closed.
3. Start the flow of instrument air to the Analyzer and verify that the pressure is adequate. (Analyzers a water-cooled cryocooler require a minimum of 4 bar / 58 psi; Analyzers with an air-cooled cryocooler require 6-8 bar / 87-116 psi).
4. Apply electrical power to the Analyzer.
5. Open the Measurement Enclosure.
6. Access the Service menu and perform the following checks (see Section 6 for information on accessing this menu and performing these functions):

```

ORB Pour Point Analyzer V3.1
-----
Submenu      Date: 01/09/13
Service      Time: 11:14:14 AM
-----
Sys Temperatures      Cell Temp. Control
T1: 0.00 C            PWM Load: 0%
Sample: 10.63 C       Heater: OFF
Sensor: CLOSE         Cooler: OFF

Output Control        Pressure System
Sample Solen.: OFF   Pres: 0
Validation : OFF     DI: 1111111
Stream Solen.: OFF

4-20 Control
Stream 1: 13.0
Stream 2: 4.0
Stream 3: 4.0

Alarms
R1 : OFF
R2 : OFF
R3 : OFF

ACTION REQUIRED:
ADVANCE to exit submenu / INDEX to scroll / UP-DOWN to change value
  
```

- A. Cycle the sample solenoid (listed under Output Control) On and Off.
- B. Verify that sample is flowing to the detection cell and check for leaks in the Measurement Enclosure.
7. Analyzers with an air-cooled cryocooler. Open the Vortex air valve and set the pressure to 2 bar (30 psi).
Analyzers with a water cooled cryocooler. Turn the coolant supply On and check for leaks.
8. Close the Measurement Enclosure door.
9. You are now ready to run analyses using the factory default settings or program the instrument with your desired operational parameters (see Section 4, Programming).

MAIN RUN SCREEN

When the P-840LT Pour Point Analyzer is powered up, a short initialization program runs and either the Main Run Screen or Main Menu will appear. The Main Run Screen appears if the unit is programmed to power up in On-Line mode; the Main Menu appears if the unit is programmed to power up in the Off-Line mode. By default, the Analyzer is programmed to power up in the Off-Line mode, but it can be customer programmed to power up in the On-Line mode. See the Systems Setting section below for more information.

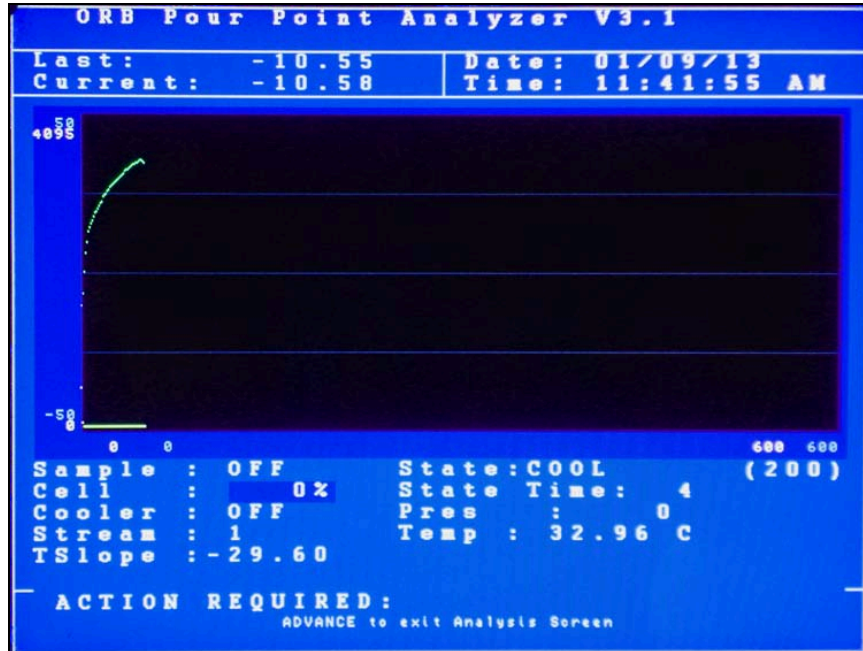

MENU NAVIGATION

The P-840LT Pour Point Analyzer is programmed and controlled via a magnetic keypad on the front of the Control Enclosure. This eliminates the need for opening the enclosure to change operational settings, etc. A magnetic pencil is supplied with the instrument for this purpose.

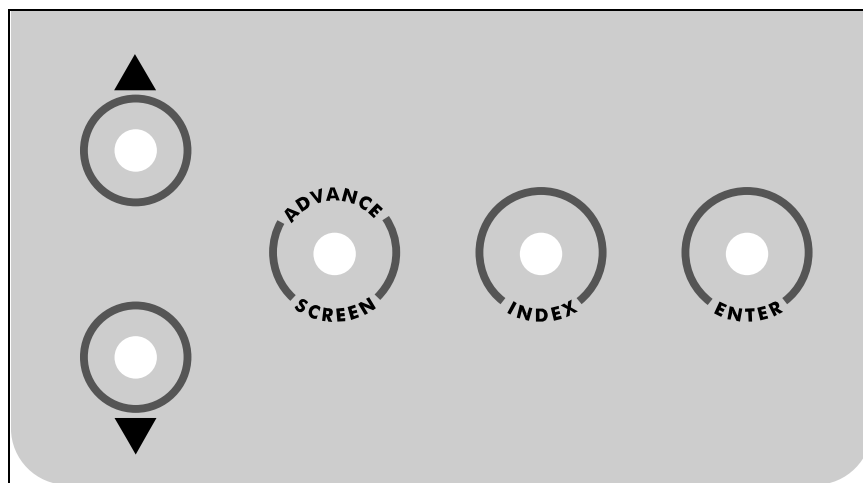

To enter or exit the analysis mode, move to a new menu or within menu items, change a displayed value, the operator simply touches a magnet to the designated location on the keypad. These locations function as follows:

Advance Screen Key — When the Main Run screen displayed, touching this key brings up the Main Menu. When any other screen is displayed, touching this key returns the display to the previous screen.

Index Key — Touching this key scrolls the Analyzer through the various items available within a specific menu. The “active” menu line is highlighted by reversing the background and foreground colors. Once you reach the last menu item, the indicator returns to the top of the menu.

Enter Key — Touching this key advances you to a sub-menu or runs a command associated with a selected menu item. It is also used to confirm some messages.

↑↓ **(Up/Down Arrow) Keys** — Touching these keys changes the displayed value for the indicated item. Depending on the specific item, it will either change the status of the selection, cycle through a list of available selections, or increase/decrease the value.

MAIN MENU

This menu is used to place the Analyzer On-Line and Off-Line. It also provides access to the all the various sub-menus. To access the Main Run screen, touch the Advance Screen key. From the Main Run screen, touch Advance Screen again to return to the Main Menu. Touch the Index key to advance to the next menu selection.

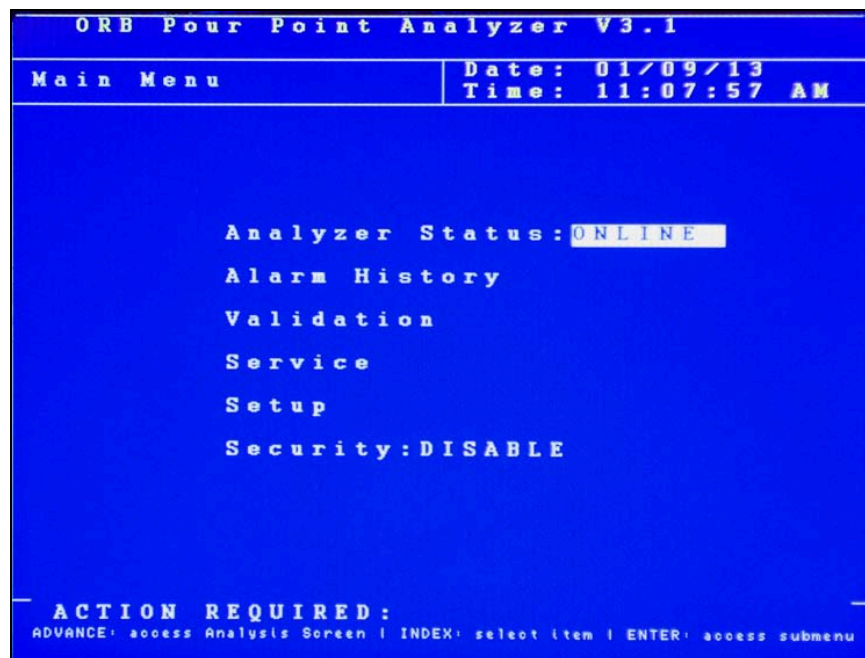

ANALYZER STATUS

This indicates the current status of the Analyzer. Touch the up/down arrow keys to change the status.

ALARM HISTORY

This menu item provides access to the Alarms History sub-menu, which lists conditions which have activated one or more of the Analyzer’s alarm functions. It is described in further detail in Section 5 – Normal Operation. Touch the Enter key to access this sub-menu.

VALIDATION

This menu item provides access to the Validation sub-menu. It allows the operator to determine how validation measurements will be initiated. Touch the Enter key to access this sub-menu and then touch the Up/Down Arrow keys to toggle through the available choices.

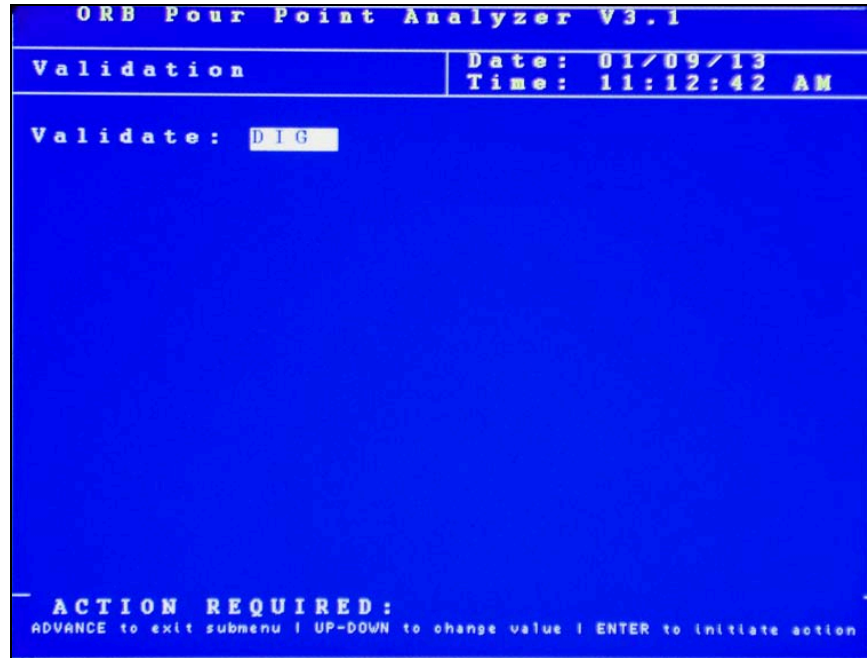

Digital — When Digital is selected, validation measurements are initiated using a dry contact closure. See Section 3 for more information on the Analyzer’s dry contacts.

Auto — When Auto is selected, validation measurements are initiated at a fixed time on a daily basis. For example, at 18:00 hours (4:00 PM). The validation start time (ST) is changed using by touching the Index key to advance to the Auto ST numerical field and then using the Up/Down Arrow keys to change the value.

SERVICE

This menu item provides access to the Service sub-menu; entering it automatically takes the Analyzer off-line. The Service menu allows you to activate various measurement system components, test the analog output, and view selected sensor readings. It is described in detail in Section 6 – Routine Maintenance & Service. Touch the Enter key to access this sub-menu.

SETUP

This menu provides access to the Analyzer’s Setup sub-menu. This sub-menu is used to establish the instrument’s output values and other operational settings. It is accessed from the Main Menu by touching the Enter key when this menu item is highlighted.

To return to the Main Run screen, touch the Advance Screen key.

SETUP SUB-MENU

The Setup sub-menu is used to establish the Analyzer's various operating parameters.

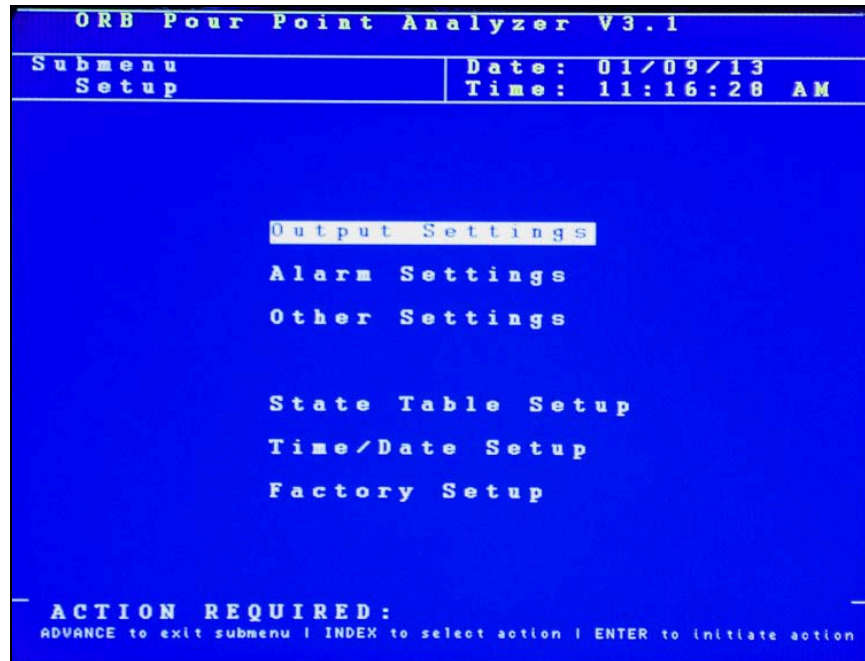

Use the Index key to advance to the desired (highlighted) menu selection. Touch the Enter key to access the selected sub-menu.

OUTPUT SETTINGS

This menu item is used to program the Analyzer's analog and digital outputs. It is also used to establish how pour point measurement information will be displayed on the Main Run screen.

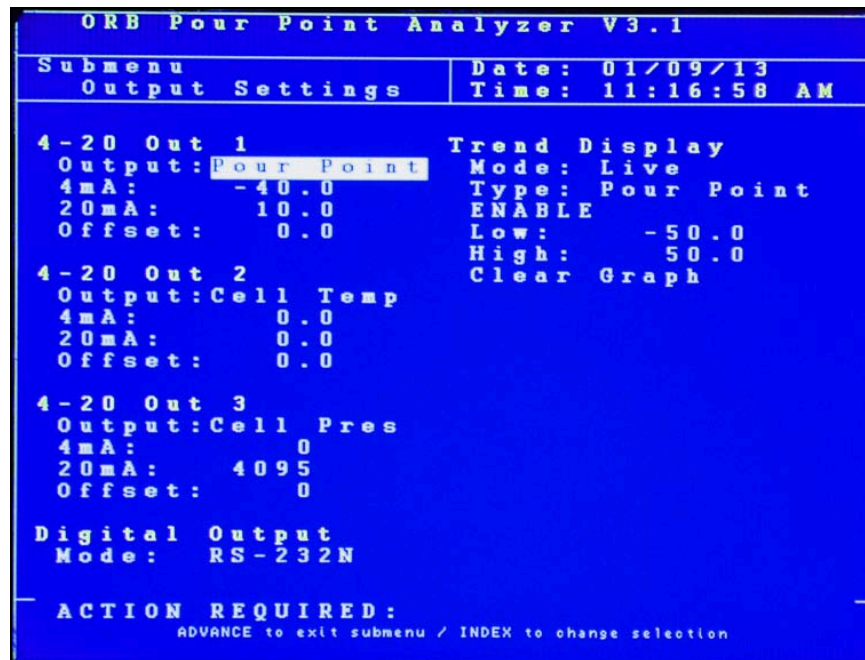

Use the Index key to advance to the desired menu item then use the Up/Down Arrow keys to change the displayed setting or value.

4-20 Out 1 / 4-20 Out 2 / 4-20 Out 3 — The P-840LT Pour Point Analyzer's analog outputs (2 standard; one optional) can be programmed to output various types of information, as well as the range of the analog signal and an offset.

Output — This menu item allows you to select the type of information that will be output using the selected analog signal. The choices are Pour Point, Cell Temperature, and Cell Pressure.

4 mA — This menu item is used to set the value at which a 4 mA signal will be output.

20 mA — This menu item is used to set the value at which a 20 mA signal will be output.

Offset — This menu selection allows you to offset the analog output signal by the programmed value.

Digital Output — This menu item allows you to select the type of digital signal the Analyzer will output. The choices are RS232N (result) or RS232D (data dump). RS232D is generally used for service and diagnostic purposes.

Trend Display — This menu item allows you to select the measurement information which will be displayed in the graphical data display section of the Main Run screen. The choices are:

Mode — This menu selection determines the type of information that is graphed on the Main Run screen.

Live — When Live is selected, information regarding the current cell temperature and cell pressure is graphed. Once pour point is detected, the screen erases and the cell temperature and pressure for the next measurement cycle graphed.

History — When History is selected, pour point results are graphed.

Type — This is an information only item; it displays the type of information that will be graphed when Live or History is selected in the proceeding menu item.

Enabled/Disabled — Turns the graphing function on/off.

Low — This establishes the bottom of the trend graph's scale.

High — This establishes the top of the trend graph's scale.

Clear Graph — This menu item is used to clear the trend display.

ALARM SETTINGS

This menu item is used to program the Analyzer's alarm output.

```

ORB Pour Point Analyzer V3.1
-----
Submenu      Alarm Settings      Date: 01/09/13
Time: 11:23:26 AM
PP Alarm 1
Low: -50.0C
High: 50.0C
PP Alarm 2
Low: -50.0C
High: 50.0C
No Detect
Time: 1200 sec
Cycle: 2 cycle

ACTION REQUIRED:
ADVANCE to exit submenu / INDEX to change selection
  
```

Use the Index key to advance to the desired menu item. Use the Up/Down Arrow keys to change the displayed setting or value.

PP Alarm 1 / PP Alarm 2 — These menu items are used to establish the temperature values at which the Analyzer's Stream 1 and Stream 2 pour point temperature warning alarms will be activated.

Low — This menu item allows you to establish the lowest allowable pour point temperature value for the selected stream. Measurements below this value generate a pour point alarm signal/message.

High — This menu item allows you to establish the highest allowable pour point temperature value for the selected stream. Measurements above this value generate a pour point alarm signal/message.

No Detect — These menu items set the maximum allowable time and number of cycles permitted to detect pour point. The critical alarm relay is activated if pour point has not been detected within the programmed values.

Time — This menu item allows you to establish the maximum allowable time permitted in a single measurement cycle to detect pour point.

Cycle — This menu item allows you to establish the maximum number of consecutive measurement cycles that can occur without detecting pour point before an alarm is activated.

OTHER SETTINGS

The Other Settings sub-menu allows you to establish global operating parameters for the Analyzer.

```

ORB Pour Point Analyzer V3.1
-----
Submenu                               Date: 01/09/13
System Settings                        Time: 11:24:30 AM
-----
Reload Defaults                         FlushHeat: 40%
Standby Mode: ON                       CellHeat: 25%
Strm Sel: STREAM 1                     Mode Settings
Come Read Time: 10                     Mode 1: Baseline
Temp Scale: C                           Mode 2: Baseline
ValidEV: -40.00C                       PP1 Thresh: 150
ValidBW: 1.00C                          PP2 Thresh: 150
Digital Inputs                          Cool Drag: 20%
Cust Alarm: ENABLE
Rem Stdby: ENABLE
Strm Sel: ENABLE
Valid: ENABLE
Screen Settings
Intensity: 100%
ScreenSaver: 15 min

Relay      Choice      Condition
R1         Alarm Critical  Fail Safe
R2         Alarm Warning  Fail Safe
R3         Come Read      Normal

ACTION REQUIRED:
ADVANCE to exit submenu / INDEX to change stream selection

```

Use the Index key to advance to the desired menu item and then select it by touching the Enter key. Use the Up/Down Arrow keys to change the displayed setting or value. Touch Enter a second time to accept the displayed setting/value.

Reload Defaults — This menu item is used to restore the Analyzer’s factory default settings. When accessed by touching the Enter key, the following message appears: “Are you sure?” Touch the appropriate key to make your selection. After the process is complete, a message will appear. Press the Enter key to continue.

	<p>NOTE: When the Analyzer’s factory default settings are restored, all user programming is lost. All operational parameters will have to be re-entered.</p>
---	---

Standby Mode — This menu item allows you to select how the Analyzer will operate upon application of power. When OFF is selected, the instrument will begin performing analyses automatically when power is applied. When ON is selected, the instrument will power up in the Off-Line mode and must be manually placed On-Line.

Stream Select — If your Analyzer is equipped with the Stream Switching option, this menu item allows you to select whether pour point measurements will be made on one or both streams.

Stream 1 / Stream 2 — The Analyzer only performs pour point measurements on the selected sample stream.

Alternate — The Analyzer alternates measurements between Streams 1 and 2.

Auto Select — Stream selection is made via a digital input signal from the control room.

Come Read Time — This menu item allows you to set the length of time the Analyzer’s “come read” relay will be activated upon the completion of a measurement cycle.

Temperature Scale — This menu item allows you to select the scale on which temperature will be displayed (°F or °C).

Valid EV — This is the expected pour point temperature.

Valid BW — This is the amount the pour point measurement can deviate (plus or minus) from the expected pour point temperature.

Digital Inputs — These menu items allow you to selectively enable/disable the Analyzer's digital inputs. See Section 3 for information on wiring these inputs.

Customer Alarm — When enabled, the Analyzer's system alarm relay will be activated whenever an external dry contact alarm signal is received. Analysis will stop and will have to be restarted from the front panel of the instrument.

Remote Standby — When enabled, the Analyzer can be placed on-line or off-line via a control room signal.

Stream Select — When enabled, a control room signal can be used to select Stream 1 or Stream 2 for analysis.

Validation — When enabled, a control room signal can be used to initiate a validation measurement.

	<p>NOTE: Although the Validation Request and Stream Select contacts may be present, these functions are only available on Analyzer's which incorporate these options.</p>
---	--

Screen Settings — These menu items allow you to adjust the Analyzer's LCD.

Intensity — This is a brightness adjustment.

Screen Saver — This establishes how long the screen will remain lit without any keypad activity. Touching any of the magnetic keys re-activates the display. A value of zero disables the screen saver.

Flush Heat — This establishes how much power should be applied when heating the detection cell during a flush step. It should be set no higher than 50%.

Cell Heat — This establishes how much power will be applied to the heater when cell heating is required. It should be set no higher than 50%.

Mode Settings — These menu items are used to set other miscellaneous operating parameters.

PP 1 Mode — This setting determines the method the Analyzer will use to detect pour point when analyzing Stream 1. The delta change from the baseline average from the end of the flush cycle to the detection of pour point is used unless problems are encountered.

PP 2 Mode — This setting determines the method the Analyzer will use to detect pour point when analyzing Stream 2. The delta change from the baseline average from the end of the flush cycle to the detection of pour point is used unless problems are encountered.

PP 1 Threshold — This is a sensitivity setting for pour point detection for Stream 1. The higher the value, the more the pressure signal will have to change before pour point is detected.

PP 2 Threshold — This is a sensitivity setting for pour point detection for Stream 2. The higher the value, the more the pressure signal will have to change before pour point is detected.

Cool Drag — This is the % power applied to the heater while the detection cell is cooling. It is intended to prevent the cryocooler from cooling the sample too rapidly. This setting should not be changed without first consulting the factory.

Relay Setup — These menu items allow you to enable/disable the alarm relays, indicate the type of alarm it will signal, and how the relay will operate.

Relay — This designates which alarm is being programmed. See Section 3 for alarm relay wiring information.

Choice — This designates the type of alarm.

Off — Alarm relay disabled.

Alarm Warning — Pour point out of range. Warning alarms do not disrupt analysis.

Alarm Critical — This type of alarm indicates Analysis has stopped because one of the following conditions has been detected:

- Pour point not detected
- Temperature sensor failure
- Temperature control failure
- Optic failure
- Customer alarm
- Remote standby enabled
- Machine not running

Come Read — Activated for a programmed period of time upon the completion of a measurement cycle.

In Validation — Activated when a validation measurement is in progress.

Validation — Activated when a validation measurement result is available.

Conditions — This designates whether the alarm relay will energize or de-energize when an alarm condition is detected. When Normal is selected, power will be applied to the relay when an alarm condition is detected; when Failsafe is selected, power will be removed from the relay when an alarm condition is detected.

STATE TABLE SETUP

This menu selection allows you to modify, add, or delete steps in the pour point measurement process.

	<p>NOTE: Any changes made will affect how the Analyzer performs a pour point measurement. You should have a complete and thorough understanding of how the instrument performs pour point measurements before making any changes to the State Table.</p>
---	---

```

ORB Pour Point Analyzer V3.1
Sub Menu      Date: 01/09/13
State Setup   Time: 11:25:03 AM

State      Type      Data
1          FLUSHHEAT  90
2          WAIT      5
3          WAIT      5
4          COOL      200
5          RETURN    0
6          RETURN    0
7          RETURN    0
8          RETURN    0
9          RETURN    0
10         RETURN    0
11         RETURN    0
12         RETURN    0
13         RETURN    0

ACTION REQUIRED:
ADVANCE to exit submenu | INDEX to scroll | UP-DOWN to change value
  
```

Any of the following steps may be included in a pour point measurement cycle. Steps highlighted in **bold face** type are required. The last step in any pour point measurement cycle must be **Return**.

Flush Heat — This applies heat to the detection cell to facilitate sample flushing before initiating a new pour point measurement. Flush may be used in lieu of Flush Heat.

Flush — This is a sample flush before initiating a new pour point measurement; sample is not heated when this state is selected. Flush Heat can be used in lieu of Flush.

Wait — This idles the Analyzer for a programmed period of time. It is generally used to allow the sample in the detection cell to stabilize.

Cool — When Cool is selected, the detection cell is cooled at a rate based on the previous pour point measurement. Cool F.R. may be used in lieu of Cool.

Cool F.R. X — When Cool F.R. is selected, the detection cell is cooled at a fixed rate per minute (in °C). Cool may be used in lieu of Cool F.R.

Cell Heat — This is used to preheat the sample prior to cooling and/or warm the sample after cooling.

Return — This should always be the last step in the State table. It tells the Analyzer to return to step 1.



02-01-2013

Factory Default State Table	
Step	Data
Flush Heat	90
Wait	5
Cool	200
Return	-
Return	-
Return	-
Return	-
Return	-
Return	-
Return	-
Return	-
Return	-
Return	-
Return	-
Return	-

TIME/DATE SETUP

The Date / Time Setting sub-menu is used to set the Analyzer's internal calendar and clock.

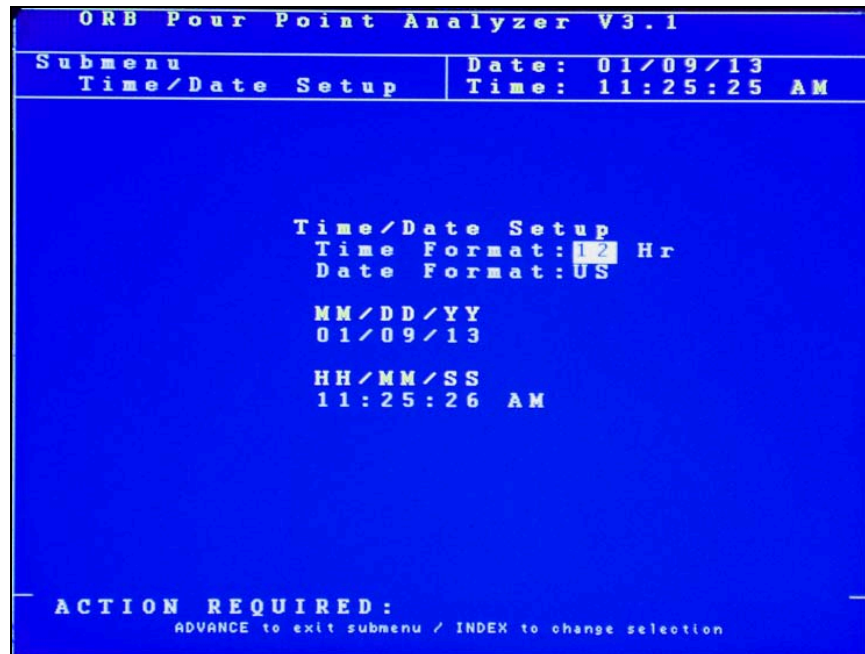

Time Format — This menu item allows you to select either a 12 or 24 hour time format. Touch the Up/Down Arrow keys to change the displayed value.

Date Format — This menu item allows you to select the format in which the date will be displayed. The selections are US (month/day/year) or EU (day/month/year). Touch the Up/Down Arrow keys to change the displayed value.

Date — This menu item allows you to program the Analyzer with the current date. To change the displayed date, touch the Enter key and then use the Index key to advance the cursor to the field which needs to change. Use the Up/Down Arrow Keys to change the value in the selected field. Touch the Enter key a second time to accept the new date entry.

Time — This menu item allows you to program the Analyzer with the current time. To change the displayed time, touch the Enter key and then use the Index key to advance the cursor to the field (Hour/Minute/Second) which needs to change. Use the Up/Down Arrow Keys to change the value in the selected field. Touch the Enter key a second time to accept the new date entry.

FACTORY SETUP

This is a password protected sub-menu intended for factory use only.

The P-840LT Pour Point Analyzer is an on-line process instrument designed for the continuous measurement of pour point in hydrocarbon process streams.

In normal operation, these measurements and other pertinent monitoring information are displayed on the Analyzer's liquid crystal display. Measurement data are also output as analog and digital signals. Upon the application of power, the P-840LT runs a short initialization program and then displays either the Main Run screen or the Main Menu, depending on how the Standby mode has been set up (see Section 4 – Programming). If the Main Run screen is displayed upon power up, the instrument is in the on-line (analyzing) mode; if the Main Menu is displayed on power up, the instrument is in the off-line (idle) mode.

MAIN RUN SCREEN

The Analyzer's Main Run screen provides both measurement data and system operation information. A typical Main Run screen appears below:

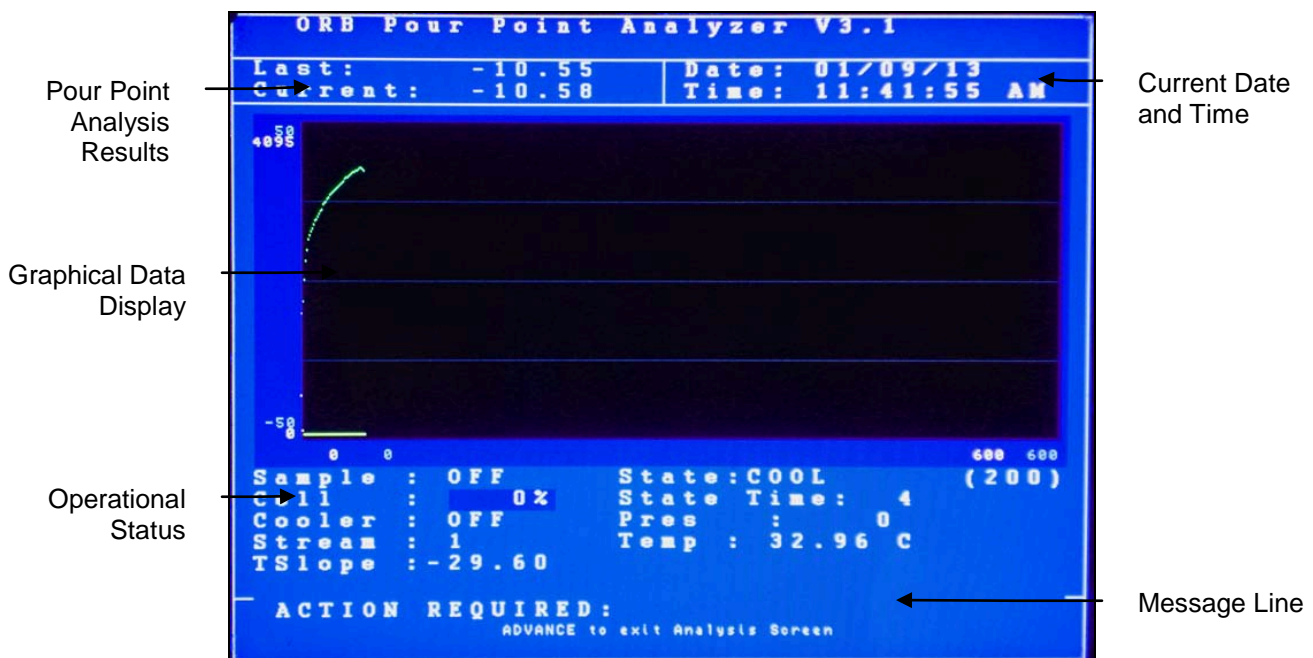

Pour Point Analysis Results — The two most recent pour point measurements. Measurement data are displayed in a user-selected unit of measure and updated at the end of each measurement cycle.

Date & Time — The current date and time as tracked by the Analyzer's internal calendar and clock.

Graphical Data Display— Displays pour point measurement data. If two sample streams are being analyzed, data appears in different colors. If power is lost or disrupted, the displayed graph is lost.

Live graph — If Live was selected as the Trend Display in the Output Settings menu (see Section 4), the graph displays temperature and pressure for the current measurement cycle.

History graph — If History was selected as the Trend Display in the Output Settings menu (see Section 4), the graph displays as many as 1000 of the most recent pour point measurements.

Operational Status — Identifies the status and state of various Analyzer components and systems.

Sample — Status of the sample solenoid.

Cell — The percent power being applied to the heater.

Cooler — Status of the cryocooler.

Stream — Identifies stream currently being analyzed (on Analyzers with the stream switching option).

T Slope — The °/minute change in the temperature of the detection cell.

State — The current step in the measurement cycle.

State Time — The elapsed or remaining time for the current state step.

Pressure — The differential pressure value of the detection cell. It is displayed as a numerical value between 0 and 4096. This value will usually be at about the mid-point of the range (~2048) after flushing and decrease slightly when pour point is reached.

Temperature — The temperature of the detection cell.

Message Line — Important operational messages, such as the detection of an alarm condition, initiation of a validation measurement, remote standby, etc. are displayed in this area.

SIGNAL OUTPUTS

4 – 20 MA ANALOG OUTPUTS

The P-840LT Pour Point Analyzer outputs analog signals proportional to the last measured values. The range of the analog signals is user-programmable (see Section 4 – Programming). The signal is updated at the end of the measurement cycle.

	NOTE: A third analog output is available as an option.
---	---

SERIAL OUTPUT

The Analyzer normally outputs an RS232 serial signal (RS485 output is available as a factory installed option). Data are output according to the following protocol:

Baud Rate	9600
Parity	No parity
Start Bits	8
Stop Bits	1
Field Delimiter	Comma
End of Data Indicator	<CR>

The information contained in the data stream is output in the following order:

Description	Format
Date	MM/DD/YY
Time	HR/MIN/SEC
Result	XX.XX° (C or F, depending on selected temperature scale.)

MODBUS OUTPUT

ModBus output is available as a factory installed option and uses the Analyzer’s serial ModBus interface or Ethernet connection. Consult ORB Instruments for additional information.

ALARMS

When an alarm condition is detected, a message will be displayed in the Message Line of the current screen. Depending on the type of alarm and the user-programming of the alarm relays, an alarm relay may also be activated.

TYPES OF ALARM CONDITIONS

Alarm Warning — This indicates that the measured pour point temperature is outside the acceptable programmed limits. Analysis continues.

Alarm Critical — An alarm of this type indicates that analysis has stopped.

Come Read — This signals that the Analyzer has completed a measurement cycle and that a new pour point value has been output. Analysis continues.

In Validation — This signals that the Analyzer is in the process of making a validation measurements.

Validation — This signals that the Analyzer has completed the validation measurement and a result is available.

When an alarm condition is detected, the appropriate alarm relay is activated (if enabled) and the alarm condition logged on the Alarms History sub-menu.

Type	Alarm Messages and Conditions	Analyzer State
Alarm Warning	Pour point out of range	Analysis continues
Alarm Critical	Pour not detected	Analysis stops
Alarm Critical	Temp. sensor failure	Analysis stops
Alarm Critical	Temp. control failure	Analysis stops
Alarm Critical	Pressure sensor failure	Analysis stops
Alarm Critical	Customer alarm	Analysis stops
Alarm Critical	Remote standby enable	Analysis stops
Alarm Critical	Machine not running	Analysis stops
Come Read	Measurement cycle complete	Analysis continues
In Validation	Validation measurement being performed	Analysis continues
Validation	Validation measurement complete	Analysis continues

	<p>NOTE: An alarm relay is activated only if one is programmed for that particular alarm type. See Section 4 – Programming.</p>
--	--

ALARMS HISTORY

Operational alarms are logged and may be accessed via the Alarms History sub-menu. To access this sub-menu, go to the Main Menu, select Alarms History, and touch Enter. The Alarms History screen will appear.

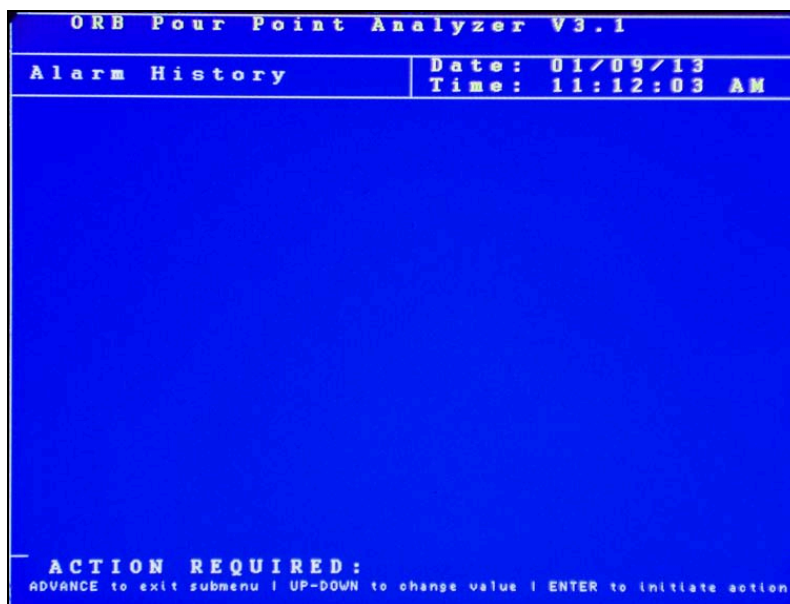

To clear the alarm history, touch the Enter key when Reset is highlighted.

TAKING THE ANALYZER OFF-LINE

The P-840LT Pour Point Analyzer may be taken off-line either locally from the front panel of the instrument or, if wired to do so, remotely via a contact closure from the control room.

LOCALLY

To exit analysis from the instrument's front panel, first access the Main Menu by touching the Advance Screen Key with the magnetic pencil and then select Status. Touch the Up/Down Arrow keys to toggle the status to OFF.

REMOTELY

The Analyzer may also be taken off-line via an optional remote dry contact relay closure (see Section 3). The instrument will remain idle until the signal is removed. A message indicating that the instrument has been remotely idled is displayed on the Main Run screen.

PERFORMING A VALIDATION MEASUREMENT

If the Analyzer is equipped with the Validation option, operating personnel can check measurement accuracy using a sample with a known pour point value. This procedure is initiated via a control room contact closure.

When a validation check is initiated, the instrument analyzes the validation sample just as it would an actual hydrocarbon sample. At the end of the measurement cycle, the measurement results for the validation sample are displayed on the Main Run screen. A message indicating that a validation measurement is in progress is displayed on the Main Run screen.



NOTE: When a validation measurement is being performed, the 4-20 mA signal is held at the last measured pour point value. The signal is not updated until a new pour point measurement is performed.

SWITCHING SAMPLE STREAMS

On P-840LT Pour Point Analyzers equipped with the stream switching option, the sample stream being analyzed can be changed from Stream 1 to Stream 2 via one of three methods (see Section 4):

Manual — Analyzes stream designated in the Other Settings sub-menu.

Alternate — Alternates between Streams 1 and 2.

Auto Select — Selects Stream 2 when a control room contact closure is activated (see Section 3). When the signal is removed, the instrument goes back to analyzing Stream 1.

The identity of the stream being analyzed is displayed on the Main Run screen.

LOSS OF POWER RESTART

In the event of a power loss, the P-840LT Pour Point Analyzer will automatically begin monitoring when power is restored. If the Standby mode (see Section 4) is set to OFF. If the Standby mode is set to ON, the Analyzer will have to be placed online manually by accessing the Main Menu and then setting Status to ON.



02-01-2013

INTERNAL SAMPLE LEAK

The Analyzer incorporates a sample leak detector mounted on the bottom of the Measurement Enclosure. Should an internal sample leak occur, accumulation of fluid in the bottom of the enclosure activates the leak detector and immediately removes power from the Measurement and Control Enclosures.

To restore power once the leak has been corrected and fluid removed from the Measurement Enclosure, press the Power Reset Button on the side of the Customer Connections Enclosure.

ROUTINE MAINTENANCE & SERVICE

SECTION 6

	WARNING: Service should only be performed by qualified service personnel. Before performing any of the following procedures, disconnect unit from its electrical source. If electrical power is required, exercise extreme care as "LINE VOLTAGE" is present.
---	--

	CAUTION: Be sure to obtain all necessary permits and perform any required gas testing before opening the instrument's enclosures.
---	--

	WARNING: To prevent injury, the Analyzer must be shut off from the process. Personnel must avoid contact with hot equipment or sample.
---	---

RECOMMENDED ROUTINE MAINTENANCE SCHEDULE

Check sample pressure	Weekly
Check sample conditioning system & filter	Weekly
Inspect for internal sample leaks	One week after startup, 30 days after startup, and then every six months
Cryocooler cooling medium	Weekly

SERVICE AND OPERATIONAL CHECKS

The P-840LT Pour Point Analyzer incorporates a special Service screen from which the operator can perform a variety of verification and diagnostic functions, including:

- Exercise the Analyzer's various components
- Output a fixed analog signal to check/calibrate external devices
- Check measurement cell temperature

Entering the Service Screen requires the Analyzer to be offline. If the Analyzer is online and the user tries to enter the Service mode, a message will appear asking "Are You Sure?" before taking Analyzer offline and entering the Service mode.



System Temperatures — This is an informational display only.

T1 — For future use.

Sample — This is the temperature inside the sample cell.

Sensor — For future use.

Output Control — The operation of the Analyzer's various solenoids can be checked via these menu items. The Up/Down Arrow keys are used to change the status.

Sample Solenoid — The Analyzer's sample solenoid valve is opened when this menu item is switched from OFF to ON.

Validation Solenoid — The Analyzer's validation solenoid valve is opened when this menu item is switched from OFF to ON.

Stream Solenoid — The Analyzer's stream switching solenoid valve is opened when this menu item is switched from OFF to ON.

	<p>NOTE: The instrument must be equipped with the validation and stream switching options in order for the Validation and Stream Solenoid menu items to function properly.</p>
---	---

4-20 Control — These menu items allow you to output an analog signal with which to calibrate external devices. The Up/Down Arrow keys are used to increase/decrease the analog signal value.

Alarms — The Analyzer's alarm relays will activate when these menu items are switched from OFF to ON.

Cell Temperature Control — These menu selections allow you to heat/cool the detection cell. When heat/cooling is applied, the system temperature information should change accordingly. The Up/Down Arrow keys are used to change the value or status of the highlighted selection.

PWM Load — This is the percent of maximum power applied to the heater.

Heater — The detection cell is heated when this menu item is switched from OFF to ON.



02-01-2013

Cooler — The detection cell is cooled when this menu item is switched from OFF to ON.

Pressure System — This menu item allows you to check the status of the pressure system.

Pressure — This is the status of the differential pressure sensor. 1 = open, 0 = closed.

DI — These values show the status of the Analyzer's various digital inputs. 1 = open, 0 = closed.



02-01-2013

[THIS PAGE INTENTIONALLY BLANK]



SPARE AND REPLACEMENT PARTS

SECTION 7

SPARE PARTS KITS

Description	Part Number
1-YEAR PARTS KIT.....	702232
Sample Hammer O-Ring, 1 each	650045
Air Operated Bypass Valve, 1 each	650047
4 Way Solenoid, 1 each.....	650019
RTD Sensor, 1 each	660001
2-YEAR PARTS KIT.....	702233
Sample Hammer, 1 each.....	650044
Sample Hammer O-Ring, 2 each	650045
Air Operated Bypass Valve, 2 each	650047
4 Way Solenoid, 2 each.....	650019
RTD Sensor, 2 each	660001



REPLACEMENT PARTS

Description	Part Number
Fuse (250 VAC, 5 A) / 115 VAC Systems, 2 each	620036
Power Supply (+5, ±12 VDC), 1 each	620037
Sample Hammer, 1 each	650044
Sample Hammer O-Ring, 1 each	650045
Sample Hammer Cap, 1 each	650046
Air Operated Bypass Valve, 1 each	650047
Differential Pressure Transducer, 1 each	650048
4 Way Solenoid, 1 each	650019
Over Temperature Bi-Metallic Switch, 1 each	660009
RTD Sensor, 1 each	660001
Magnetic Keypad Assembly, 1 each	798030
Graphics Display Assembly, 1 each	700286
Display Controller PCB, 1 each	798063
Backlight Driver PCB, 1 each	700288
Cable Assembly, 1 each	700289
Pour Point I/O PCB Assembly, 1 each	798021
Pour Point Converter PCB Assembly, 1 each	798024
Main Control PCB, 1 each	700318
Power Supply (+24 VDC), 1 each	620038
TE Driver PCB, 1 each	620079
Pour Point Analysis Module, 1 each	700520