



Note on instructions

When working in hazardous areas, the safety of personnel and equipment depends on compliance with the relevant safety regulations. The people in charge of installation and maintenance bear a special responsibility. It is essential that they have an exact knowledge of the applicable rules and regulations.

The instructions provide a summary of the most important safety measures and must be read by everyone working with the product so that they will be familiar with the correct handling of the product.

The instructions have to be kept for future reference and must be available throughout the expected life of the product.

Description

The switch module, type 07-3321-1*00, is used everywhere in almost all hazardous areas where machine functions are to be activated by pressing a button or actuating a switch.

The switch module is equipped with self-cleaning contacts featuring positive break operation. The switch module is intended for fitting onto a mounting rail. Connection is established by means of terminals.

The switch modules are flexible in use and offer a range of actuator elements. Each actuating element is fitted into a mounting hole on a control console or panel.

Explosion protection

ATEX

Ex type of protection

II 2G Ex db eb IIC Gb

I M2 Ex db eb I Mb

Certification

CML 17 ATEX 1105 U

IECEX

Ex type of protection

Ex db eb IIC Gb

Ex db eb I Mb

Certification

IECEX CML 17.0045U

Other approvals and certificates, see www.bartec-group.com

Ambient temperature ranges

-55 °C to +60 °C
(-67 °F to +140 °F)

oder

-55 °C bis +40 °C
(-67 °F bis +104 °F)

Operating temperature ranges

-55 °C bis +85 °C
(-67 °F bis +185 °F)

Approved for zone

1 and 2

Storage/transport temperature

-55 °C to +70 °C
(-67 °F to +158 °F)

Technical data

Protection class

Determined by actuating element and control unit enclosure.

Terminals: IP 20

Weight

Approx. 70 g (0.15 lb)

Enclosure material

Thermoplastic

Contact material

AgSnO₂

Rated insulation voltage

690 V

Rated voltage

AC 230 V and 400 V

DC 24 V and 110 V

Contacts

1 N/C contact and 1 N/O contact or 2 N/O contacts or 2 N/C contacts

Switching capacity

AC-15	400 V	10 A
AC-12	400 V	16 A
DC-13	24 V	1 A
DC-13	110 V	0,5 A

Conventional thermal current

16 A / +40 °C (+104 °F)

11 A / +60 °C (+140 °F)

Min. rated operating current

10 mA / 24 V

Connection

Terminal for 2.5 mm², fine-wire

Service life

Mechanical: > 10⁵ switching cycles

Mounting

On mounting rail NS 35/7.5

Shock resistance

DIN EN 60068-2-27: 30 g 18 ms

Dimensions

See page 3

Safety Instructions

The switch module and its actuating element may be used only within the specified ambient and operating temperature range. Incorrect installation can cause malfunctioning and the loss of explosion protection.

Utilization in areas other than those specified or the alteration of the product by anyone other than the manufacturer will exempt BARTEC from liability for defects or any further liability.

Only service technicians who are authorized to work in potentially explosive atmospheres may do any of the assembly, disassembly, installation, commissioning, maintenance, and fault clearance work.

The generally applicable statutory rules and other binding directives relating to workplace safety, accident prevention and environmental protection must be observed.

When setting up or operating explosion-resistant electrical systems, the IEC/EN 60079-14 (NEC for USA/CEC for Canada) and all relevant installation and operating regulations must be observed.

The switch module may be used only if it is clean and not damaged in any way. It is not permissible to modify the module in any way.

Marking

Particularly important points in these instructions are marked with a symbol:

⚠ DANGER

DANGER indicates a hazardous situation which, if not avoided, will result in death or serious injury.

⚠ WARNING

WARNING indicates a hazardous situation which, if not avoided, could result in death or serious injury.

⚠ CAUTION

CAUTION indicates a hazardous situation which, if not avoided, could result in minor or moderate injury.

NOTICE

NOTICE is used to address practices not related to personal injury.

i Note

Important instructions and information on effective, economical and environmentally compatible handling.

Standards conformed to

EN 60079-0:2012+A11:2013
EN 60079-1:2014
EN 60079-7:2015
EN 60068-2-27:2009
IEC 60079-0:2011
IEC 60079-1:2014-06
IEC 60079-7:2015
IEC 60068-2-27:2008

Transport, Storage

NOTICE

Switch module damage through incorrect transport or incorrect storage.

- Transport and storage is permissible in original packaging only.
- Store the switch module in a dry place.

Assembly, Installation

⚠ WARNING

Risk of serious injury due to incorrect proceedings.

- The IEC/EN 60079-14 and further national standards and locally applicable installation regulations have to be observed.
- Ensure that the voltage supply has been isolated or take suitable protective measures.

Assembly

⚠ WARNING

Risk of serious accidents due to damaged parts.

- Before assembly, ensure the perfect condition of the components.

Mounting the switch module:

- Make sure the switch module to be attached is intact (no cracks).
- Put the switch module on the mounting rail.
- Align the position of the switch module on the mounting rail at the actuating element.

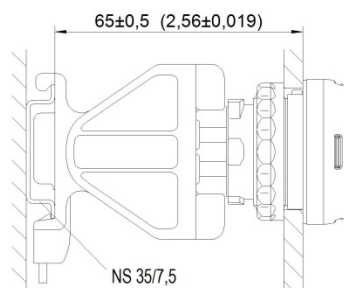

i Note

The assembly of the actuating element is described in the operating instructions for actuating elements, type 05-0003-00**/****.

Installation

In hazardous areas groups I and II, the switch module must be used:

- In appropriate enclosures with "Ex e" increased safety type of protection. The clearance and creepage distances under IEC/EN 60079-7 Section 4.3, Section 4.4 and Table 1 must be observed.
- In an enclosure that corresponds to another approved type of protection specified in IEC/EN 60079-0 Section 1.

Take care when connecting conductors:

- Strip 40 mm (1.6 in) sheath off the conductor.
- Remove approx. 6 mm (0.2 in) conductor insulation from the cores.
- Prepare the ends of fine-stranded and multi-stranded conductors: Crimp wire end sleeves with suitable crimping tools. Connection cross-sections: 0.75-2.5 mm² (14-18 AWG).
- Release terminals.
- Insert conductors.
- Tight the terminals with a maximum torque of 0.4-0.7 Nm (0.3-0.5 lb.ft).

Contact arrangements:

Type 073321-1100

2 N/C contacts

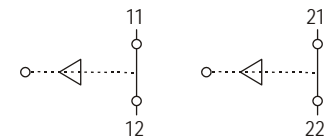

Type 07-3321-1200

2 N/O contacts

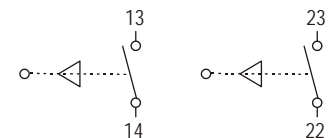

Type 07-3321-1400

1 N/O contact and 1 N/C contact

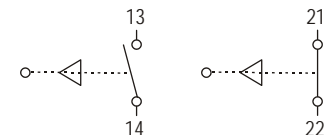

Commissioning

Before commissioning, check that:

- The switch module has been mounted and installed in compliance with regulations.
- The switch module is not damaged.
- The connection has been established properly (make sure the cores are secure).
- Functional and recurring inspections must be conducted at regular intervals. The plant operator must define the test intervals for the respective application. The properties of AgSnO₂ contacts must be taken into account in the case of low supply voltage (DC 24V) and long periods between actuation. I.e. used in applications with low voltage/low current, such as PLC signal-switching, and in saline or other corrosive environments it is recommended to increase test interval frequency to minimum once per year.

Operation

⚠ DANGER

Death or serious injury through improper use.

- The switch module may be operated only within the technical limits that apply to it (see page 1).

Maintenance and Fault Clearance

⚠ WARNING

Risk of serious injury due to incorrect proceedings.

- IEC/EN 60079-17 must be observed. It is recommended to formulate a maintenance plan according to this standard.
- Ensure that the voltage supply has been isolated or take suitable protective measures.

Maintenance

⚠ WARNING

Risk of serious accidents due to damaged parts.

- Check switch modules, actuating elements, actuators, screw fittings, sealings and cables regularly for cracks and damage. Make sure that they are properly established.
- Functional and recurring inspections must be conducted at regular intervals. The plant operator must define the test intervals for the respective application. The properties of AgSnO₂ contacts must be taken into account in the case of low supply voltage (DC 24V) and long periods between actuation. I.e. used in applications with low voltage/low current, such as PLC signal-switching, and in saline or other corrosive environments it is recommended to increase test interval frequency to minimum once per year.

NOTICE

Switch module/ actuating element damage due to incorrect cleaning.

- It is not allowed to clean switch modules/ actuating elements with compressed air.

The operator of the switch module must keep it in good condition, operate it properly, monitor it and clean it regularly.

The owner/managing operator must schedule maintenance intervals which will suit the respective conditions of use.

Fault Clearance

⚠ WARNING

Risk of serious injury due to use of non-original spare parts.

- Use original parts only as replacements.

The switch module is defective if the switching unit does not perform switching functions any longer. Defective switch modules cannot be repaired; they must be replaced considering this operational instruction.

Defective actuating elements can be removed from the switch module and replaced by functioning actuating elements of the same type.

i Note

For original parts, contact the firm of Bartec GmbH at the service address.

Accessories, Spare Parts

For accessories and spare parts, see BARTEC catalogue.

Disposal

i Note

Environmental damage can be caused by incorrect waste disposal. When in doubt, local authorities or specialist disposal companies can provide information on environmentally friendly disposal.

The components in the switch module and the actuating element contain metal and plastic parts. Therefore the statutory requirements for disposing of electronic scrap must be observed.



Service Address

BARTEC GmbH
Max-Eyth-Straße 16
97980 Bad Mergentheim
Germany
Tel.: +49 7931 597-0
Fax: +49 7931 597-119

Dimensions in mm (in)

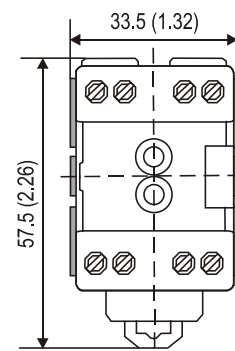
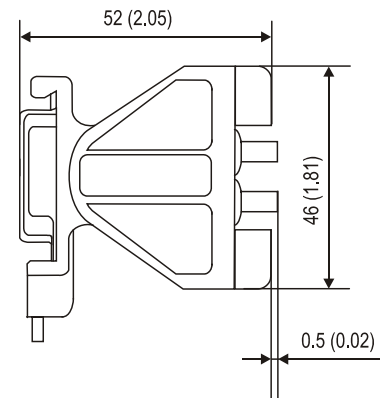

EU Konformitätsbescheinigung
EU Attestation of Conformity
Attestation UE de conformité

BARTEC

N° 01-3320-7C0001_E

Wir	We	Nous
BARTEC GmbH Max-Eyth-Straße 16 97980 Bad Mergentheim Germany		
erklären in alleiniger Verantwortung, dass das Produkt Schaltmodul Steuerschalter ComEx Schaltmodul, 4-polig	declare under our sole responsibility that the product Switch Module Control Switch ComEx Switch module, 4-pole	attestons sous notre seule responsabilité que le produit Elément de contact Interrupteur de commande Module de commutation, 4-polaire

Typ 07-332*-****/****, 07-333*-****/****, 07-3381-****/****

auf das sich diese Erklärung bezieht den Anforderungen der folgenden Richtlinien (RL) entspricht ATEX-Richtlinie 2014/34/EU RoHS-Richtlinie 2011/65/EU RoHS-Richtlinie 2015/863/EU und mit folgenden Normen oder normativen Dokumenten übereinstimmt	to which this declaration relates is in accordance with the provision of the following directives (D) ATEX-Directive 2014/34/EU RoHS-Directive 2011/65/EU RoHS-Directive 2015/863/EU and is in conformity with the following standards or other normative documents	se référant à cette attestation correspond aux dispositions des directives (D) suivantes Directive ATEX 2014/34/EU Directive RoHS 2011/65/EU Directive RoHS 2015/863/EU et est conforme aux normes ou documents normatifs ci-dessous
EN 60079-0:2012 + A11:2013 EN 60079-1:2014 EN 60079-7:2015		EN 61508-1:2010 EN 61508-2:2010 EN 60947-5-4:2003

Verfahren der EU-Baumusterprüfung / Benannte Stelle	Procedure of EU-Type Examination / Notified Body	Procédure d'examen UE de type / Organisme Notifié
---	--	---

CML 17 ATEX 1105 U⁽¹⁾, Issue 3

2276, CML B.V., Hoogoorddreef 15, 1101BA Amsterdam, NL

⁽¹⁾ Die Ex-Komponente ist Teil eines elektrischen Betriebsmittels oder eines Moduls, gekennzeichnet mit dem Symbol „U“, das nicht für sich allein verwendet werden darf und über dessen Einbau in elektrische Betriebsmittel oder Systeme zur Verwendung in explosionsgefährdeten Bereichen gesondert entschieden werden muss. Merkmale dieser Komponente sowie die Bedingungen für ihren Einbau in Geräte und Schutzsysteme siehe Betriebsanleitung der Komponente.	⁽¹⁾ The Ex-component is a part of an electrical apparatus or a module, marked with the symbol "U", which is not intended to be used alone and requires additional consideration when incorporated into electrical apparatus or systems for use in explosive atmospheres. Characteristics and how the component must be incorporated into equipment or protective systems see operation manual of the component.	⁽¹⁾ Le composant Ex est partie de matériel électrique ou de module, marquée du symbol « U », ne devant pas être utilisée seule et nécessitant une certification complémentaire lorsqu'elle est incorporée à un matériel électrique ou à un système pour atmosphères explosives. Les caractéristiques du composant ainsi que les conditions d'incorporation dans des appareils ou des systèmes de protection regarde voir l'instruction d'emploi du composant.
--	---	---

0044

Bad Mergentheim, 23.08.2019

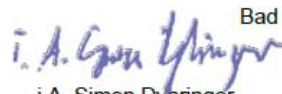
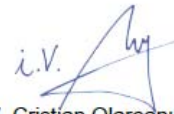
i.A. Simon Dynringer
Product Manager Ex e

i.V. Cristian Olareanu
Team Leader Certification Center