



Note on instructions

When working in hazardous areas, the safety of personnel and equipment depends on compliance with the relevant safety regulations. The people in charge of installation and maintenance bear a special responsibility. It is essential that they have an exact knowledge of the applicable rules and regulations.

The instructions provide a summary of the most important safety measures and must be read by everyone working with the product so that they will be familiar with the correct handling of the product.

The instructions have to be kept for future reference and must be available throughout the expected life of the product.

Description

The control switch, type 07-3331-1..., has been designed to solve a great variety of problems encountered in chemical and petrochemical plants and in explosion-proofed electrical machinery.

Four switch contacts as opening and closing elements in different permutations permit a large number of functions. The NC contacts have positive break operation. The switch actuator allows both latching and momentary contact with different switch positions.

The control switch can be installed quickly and directly onto a mounting rail, either in double or triple ComEx enclosures or in combination with other command devices in control units.

Explosion Protection

ATEX

Ex type of protection

II 2G Ex db eb IIC Gb

I M2 Ex db eb I Mb

Certification

CML 17 ATEX 1105 U

IECEx

Ex type of protection

Ex db eb IIC Gb

Ex db eb I Mb

Certification

IECEx CML 17.0045U

Other approvals and certificates, see www.bartec-group.com

Ambient temperature ranges

-55 °C to +60 °C

(-67 °F to +140 °F)

Operating temperature ranges

-55 °C bis +85 °C

(-67 °F bis +185 °F)

Approved for zone

1 and 2

Storage/transport temperature

-55 °C to +70 °C

(-67 °F to +158 °F)

Technical data

Connection

Terminals 2.5 mm² (14 AWG), fine-stranded

Contact material

AgSnO₂

Enclosure material / manufacturing process

Thermoplastic / injection moulding

Installation

- On mounting rail NS35/7.5
- Front mounting:
 - With mounting set -187 for wall thicknesses from 1 to 2 mm (0.04 to 0.08 in)
 - With mounting set -188 for wall thicknesses from 2.5 to 5 mm (0.1 to 0.2 in)

See also separate operational instruction "Mounting set", order number 05-0091-0187 and 05-0091-0188

Technical Data

Switch function

- Max. 4 switch contacts
- Various NC/NO contact assemblies
- Latching and momentary-contact functions with different switch positions

Contacts

Contacts with positive break operation (self-cleaning)

Installation possibilities

- Double and triple ComEx enclosures
- In control units

Switch isolator

IEC/EN 60947-3 (main motor switch)

P/AC-3/AC-23 A	AC-3	AC-23
230 V	3ph/ 3 kW	1ph/ 2.2 kW
400 V	3ph/ 5.5 kW	1ph/ 3 kW

I_e = AC-23/400 V/10 A

Control switch to IEC/EN 60947-5-1 (auxiliary circuit switch)

AC-15	400 V	10 A
AC-12	400 V	16 A
DC-13	24 V	1 A

Rated insulation voltage

U_i = 690 V

U_e = 400 V

Rated impulse strength

U_{imp} = 6 kV

Conditional rated short-circuit current at 400 V

I_e = 4 kA

Short-circuit current (max. back-up fuse I.v.h.b.c)

Max. 16 A

Nominal thermal current

+40 °C (+104 °F) I_{the} = 16 A

+60 °C (+140 °F) I_{the} = 11 A

Min. rated operating current

10 mA / 24 V

Shock resistance

DIN EN 60068-2-27: 30 g 18 ms

Weight

Approx. 173 g (0,38 lb)

Dimensions

See page 3

Safety Instructions

The control switch and the corresponding position selector switch may be used only within the specified ambient and operating temperature range. Incorrect installation can cause malfunctioning and the loss of explosion protection.

Utilization in areas other than those specified or the alteration of the product by anyone other than the manufacturer will exempt BARTEC from liability for defects or any further liability.

Only service technicians who are authorized to work in potentially explosive atmospheres may do any of the assembly, disassembly, installation, commissioning, maintenance, and fault clearance work.

The generally applicable statutory rules and other binding directives relating to workplace safety, accident prevention and environmental protection must be adhered to.

When setting up or operating explosion-resistant electrical systems, the IEC/EN 60079-14 (NEC for USA/CEC for Canada) and all relevant installation and operating regulations must be observed.

The control switch may be used only if it is in a clean and undamaged condition. It is not permissible to modify the control switch in any way.

Marking

Particularly important points in these instructions are marked with a symbol:

⚠ DANGER

DANGER indicates a hazardous situation which, if not avoided, will result in death or serious injury.

⚠ WARNING

WARNING indicates a hazardous situation which, if not avoided, could result in death or serious injury.

⚠ CAUTION

CAUTION indicates a hazardous situation which, if not avoided, could result in minor or moderate injury.

NOTICE

NOTICE is used to address practices not related to personal injury.

i Note

Important instructions and information on effective, economical and environmentally compatible handling.

Standards conformed to

EN 60079-0:2012+A11:2013
 EN 60079-1:2014
 EN 60079-7:2015
 EN 60068-2-27:2009
 IEC 60079-0:2011
 IEC 60079-1:2014-06
 IEC 60079-7:2015
 IEC 60068-2-27:2008

Transport, Storage

NOTICE

Control switch damage through incorrect transport or incorrect storage.

- Transport and storage is permissible in original packaging only.
- Store the control switch in a dry place.

Assembly, Installation

⚠ WARNING

Risk of serious injury due to incorrect proceedings.

- The IEC/EN 60079-14 and further national standards and locally applicable installation regulations have to be observed.
- Ensure that the voltage supply has been isolated or take suitable protective measures.

Assembly

⚠ WARNING

Risk of serious accidents due to damaged parts.

- Before assembly, ensure the perfect condition of the components.

Check when assembling:

- Make sure the control switch to be attached is intact (no cracks).
- Install the control switch in such a way that it is mechanically protected against impact energy.
- Make sure that the connection lead met the thermal and mechanical requirements of the area of application.

On mounting rail

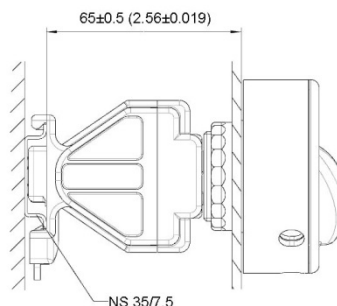

Front mounting is only possible for control switches with position selector switches with protective collar.

i Note

There are two mounting sets available for control switches with position selector switches with protective collar. The mounting sets and the assembly of the mounting sets are described in the operating instruction, type 05-0091-0187 and type 05-0091-0188.

Installation

In hazardous areas groups I and II, the control switch must be used:

- In appropriate enclosures with “Ex e” increased safety type of protection. The clearance and creepage distances under IEC/EN 60079-7 Section 4.3, Section 4.4 and Table 1 must be observed.
- In an enclosure that corresponds to another approved type of protection specified in IEC/EN 60079-0 Section 1.

Take care when connecting conductors:

- Strip 40 mm (1.6 in) sheath off the conductor.
- Remove approx. 6 mm (0.2 in) conductor insulation from the cores.
- Prepare the ends of fine-stranded and multi-stranded conductors: Crimp wire end sleeves with suitable crimping tools. Supply cable, cross-sections: 0.75-2.5 mm², one-wire (14-18 AWG), 0.75-1.5 mm², fine-stranded, wire end ferrule (16-18 AWG).
- Release terminals.
- Insert conductors.
- Tight the terminals with a maximum torque of 0.4-0.7 Nm (0.3-0.5 lb.ft).

Commissioning

Before commissioning, check that:

- The control switch has been installed in compliance with regulations.
- The control switch is not damaged.
- The connection has been established properly.
- Functional and recurring inspections must be conducted at regular intervals. The plant operator must define the test intervals for the respective application. The properties of AgSnO₂ contacts must be taken into account in the case of low supply voltage (DC 24V) and long periods between actuation. I.e. used in applications with low voltage/low current, such as PLC signal-switching, and in saline or other corrosive environments it is recommended to increase test interval frequency to minimum once per year.

Operation

⚠ DANGER

Death or serious injury through improper use.

- The control switch may be operated only within the technical limits that apply to it (see page 1).

Maintenance and Fault Clearance

⚠ WARNING

Risk of injury due to incorrect proceedings.

- IEC/EN 60079-17 must be observed. It is recommended to formulate a maintenance plan according to this standard.
- Ensure that the voltage supply has been isolated and take suitable protective measures.

Maintenance

⚠ WARNING

Risk of serious accidents due to damaged parts.

- Check control switch, position selector switch, screw fittings and cables regularly for cracks and damage. Make sure that they are properly established.
- Functional and recurring inspections must be conducted at regular intervals. The plant operator must define the test intervals for the respective application. The properties of AgSnO₂ contacts must be taken into account in the case of low supply voltage (DC 24V) and long periods between actuation. I.e. used in applications with low voltage/low current, such as PLC signal-switching, and in saline or other corrosive environments it is recommended to increase test interval frequency to minimum once per year.

The operator of the control switch must keep it in good condition, operate it properly, monitor it and clean it regularly.

The owner/managing operator must schedule maintenance intervals which will suit the respective conditions of use.

i Note

It is not allowed to clean switch modules/actuating elements with compressed air.

Fault Clearance

⚠ WARNING

Risk of serious injury due to use of non-original spare parts.

- Use original parts only as replacements.

The control switch is defective if the switching unit does not perform switching functions any longer. Defective control switches cannot be repaired; they must be replaced considering this operational instruction.

Defective position selector switches can be taken out and replaced by functioning position selectors of the same type.

i Note

For original parts, contact the firm of Bartec GmbH at the service address.

Accessories, Spare Parts

See BARTEC catalogue.

Disposal

i Note

Environmental damage can be caused by incorrect waste disposal. When in doubt, local authorities or specialist disposal companies can provide information on environmentally friendly disposal.

The components in the switch contain metal and plastic parts. Therefore the statutory requirements for disposing of electronic scrap must be observed.



Service Address

BARTEC GmbH
Max-Eyth-Straße 16
97980 Bad Mergentheim
Germany
Tel.: +49 7931 597-0
Fax: +49 7931 597-119

Dimensions in mm (in)

Front view

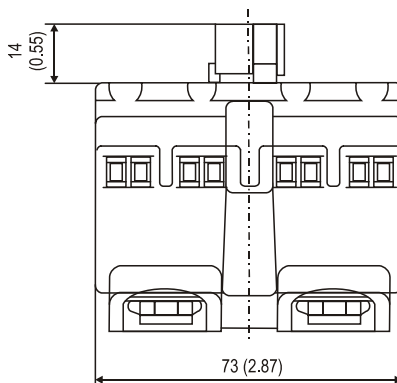

Side view

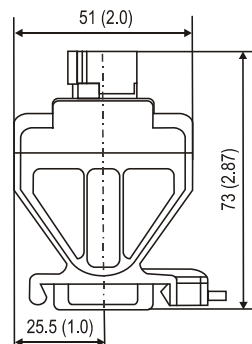

Plan view

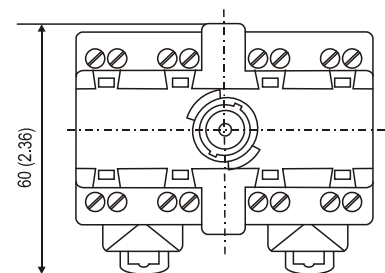

Contact Arrangements in Control Switch

Type 07-3331-1A01

	13	23	33	43
0				
I	X	X	X	X
	14	24	34	44

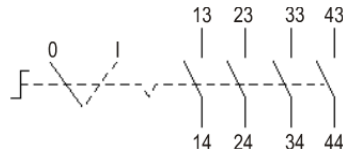

Type 07-3331-1C06

	13	23	33	43
I	X	X		
0				
II			X	X
	14	24	34	44

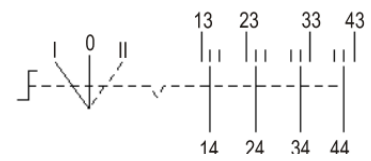

Type 07-3331-1A02

	13	23	31	41
0			X	X
I	X	X		
	14	24	32	42

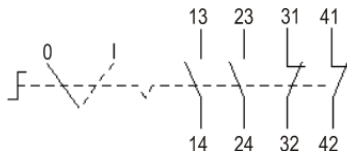

Type 07-3331-1C07

	13	23	31	41
0			X	X
I				
II	X	X		
	14	24	32	42

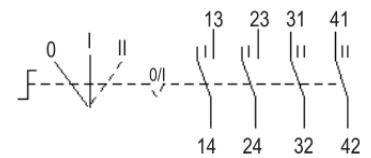

Type 07-3331-1A03

	11	23	33	43
0	X			
I		X	X	X
	12	24	34	44

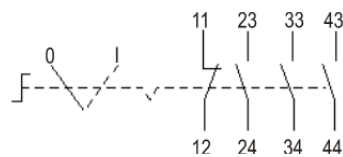

Type 07-3331-1E08

	11	23	33	43
0	X			
I		X		
II			X	X
	12	24	34	44

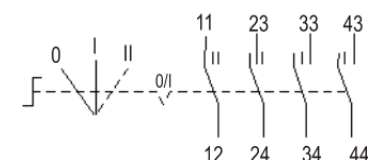

Type 07-3331-1A04

	11	21	31	43
0	X	X	X	
I				X
	12	22	32	44

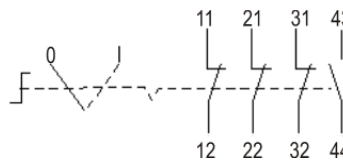

Type 07-3331-1E09

	13	23	33	43
I	X	X		
0				
II			X	X
	14	24	34	44

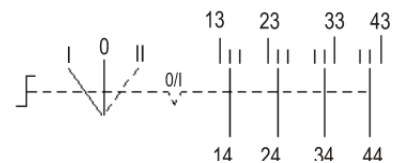

Type 07-3331-1H05

	11	23	33	43
0	X			
I		X		
II			X	
III				X
	12	24	34	44

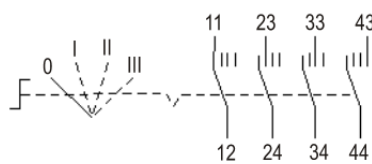

Type 07-3331-1L01

	13	23	33	43
0				
I	X			
II		X		
III			X	
IV				X
	14	24	34	44

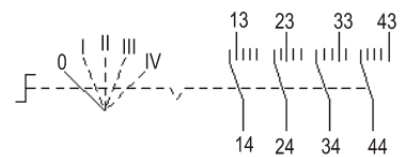

Contact Arrangements in Switch Isolator

Type 07-3331-1N01

	1	3	5	13
0				
I	X	X	X	X
	2	4	6	14

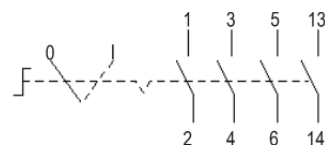

Type 07-3331-1N02

	1	3	5	11
0				X
I	X	X	X	
	2	4	6	12

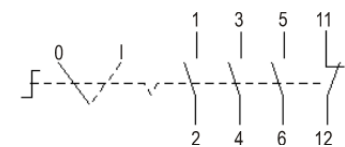

01-3331-7D0001/A-08/19-STVT-292824

EU Konformitätsbescheinigung
EU Attestation of Conformity
Attestation UE de conformité



Nº 01-3320-7C0001_E

Wir	We	Nous
BARTEC GmbH Max-Eyth-Straße 16 97980 Bad Mergentheim Germany		
erklären in alleiniger Verantwortung, dass das Produkt Schaltmodul Steuerschalter ComEx Schaltmodul, 4-polig	declare under our sole responsibility that the product Switch Module Control Switch ComEx Switch module, 4-pole	attestons sous notre seule responsabilité que le produit Elément de contact Interrupteur de commande Module de commutation, 4-po- laire

Typ 07-332*-****/****, 07-333*-****/****, 07-3381-****/****

auf das sich diese Erklärung bezieht den Anforderungen der folgen- den Richtlinien (RL) entspricht ATEX-Richtlinie 2014/34/EU RoHS-Richtlinie 2011/65/EU RoHS-Richtlinie 2015/863/EU und mit folgenden Normen oder nor- mativen Dokumenten übereinstimmt	to which this declaration relates is in accordance with the provision of the following directives (D) ATEX-Directive 2014/34/EU RoHS-Directive 2011/65/EU RoHS-Directive 2015/863/EU and is in conformity with the following standards or other normative documents	se référant à cette attestation correspond aux dispositions des direc- tives (D) suivantes Directive ATEX 2014/34/EU Directive RoHS 2011/65/EU Directive RoHS 2015/863/EU et est conforme aux normes ou docu- ments normatifs ci-dessous
EN 60079-0:2012 + A11:2013 EN 60079-1:2014 EN 60079-7:2015		EN 61508-1:2010 EN 61508-2:2010 EN 60947-5-4:2003

Verfahren der EU-Baumuster- prüfung / Benannte Stelle	Procedure of EU-Type Examination / Notified Body	Procédure d'examen UE de type / Organisme Notifié
--	---	--

CML 17 ATEX 1105 U⁽¹⁾, Issue 3

2276, CML B.V., Hoogoorddreef 15, 1101BA Amsterdam, NL

⁽¹⁾ Die Ex-Komponente ist Teil eines elektrischen Betriebsmittels oder eines Moduls, gekennzeichnet mit dem Symbol „U“, das nicht für sich allein verwendet werden darf und über dessen Einbau in elektrische Betriebsmittel oder Systeme zur Verwendung in explosionsgefährdeten Bereichen gesondert entschieden werden muss. Merkmale dieser Komponente sowie die Bedingungen für ihren Einbau in Geräte und Schutzsysteme siehe Betriebsanleitung der Komponente.	⁽¹⁾ The Ex-component is a part of an electrical apparatus or a module, marked with the symbol "U", which is not intended to be used alone and requires additional consideration when incorporated into electrical apparatus or systems for use in explosive atmospheres. Characteristics and how the component must be incorporated into equipment or protective systems see operation manual of the component.	⁽¹⁾ Le composant Ex est partie de matériel électrique ou de module, marquée du symbol « U », ne devant pas être utilisée seule et nécessitant une certification complémentaire lorsqu'elle est incorporée à un matériel électrique ou à un système pour atmosphères explosives. Les caractéristiques du composant ainsi que les conditions d'incorporation dans des appareils ou des systèmes de protection regarde voir l'instruction d'emploi du composant.
--	---	---

0044

Bad Mergentheim, 23.08.2019

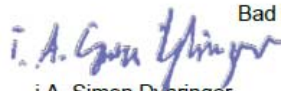

i.A. Simon Dynringer
Product Manager Ex e

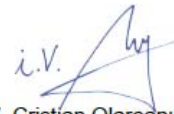

i.V. Cristian Olareanu
Team Leader Certification Center