

Proximity Switch

Type 07-.211-..../....



Proximity switch

Type 07-.211-..../....



Description

The proximity switch, type 07-.211-..../...., is a magnetic operated switch, available with either normally closed (N/C), normally open (N/O) or changeover (C/O) contacts. The normal way of actuating the switch is to bring a permanent magnet into close proximity with the switch housing. As with any magnet reed switch, the proximity switch can be operated in many different ways using various magnet types. The proximity switch has been designated as group II category 2 equipment and is suitable for installation in zone 1 and zone 2 gas hazardous areas and zone 21 and zone 22 dust hazardous areas providing that all conditions for safe use are complied with. The proximity switch carries a temperature classification of T6 for gas and T 80 °C for dust.

Notes about the instructions

When working in hazardous areas, the safety of personnel and equipment depends on compliance with the relevant safety regulations. The people in charge of installation and maintenance bear a special responsibility. It is essential that they have an exact knowledge of the applicable rules and regulations. The instructions provide a summary of the most important safety measures and must be read by everyone working with the product so that they will be familiar with the correct handling of the product. The instructions have to be kept for future reference and must be available throughout the expected life of the product.

Explosion protection

Marking ATEX	Ex II 2 G Ex mb IIC T6 Gb Ex II 2 D Ex mb IIIC T80 °C Db IP 68
Certification	Baseefa05ATEX0159X/2
Marking IECEx	Ex mb IIC T6 Gb Ex mb IIIC T80 °C Db IP68
Certification	IECEx BAS 06.0020X
Other approvals and certificates, see www.bartec.com	
Ambient temperature ranges	See page 2.
Approved for zones	1, 2 and 21, 22

Technical data

Protection class	IP 68 (EN 60529)
Housing material	Celanex 3226
Contact form, cable end details	see page 2
Cable length, dimensions	see page 2
Normally closed (NC) Type 07-2211-2*10	
Contact rating	max. 5 VA/W
Switching voltage	max. 175 V AC/DC
Switching current	max. 0.25 A
Resistance	contact: max. 0.1 Ω insulation: min. 10 ⁹ Ω
Capacitance	1.0 pF
Operate time / release time	max. 0.7 ms / max. 1.0 ms
Shock resistance	vibration: max. 30 G shock: max. 50 G
Normally open (NO) Type 07-2211-2*20	
Contact rating	max. 10 VA/W
Switching voltage	max. 200 V AC/DC
Switching current	max. 0.5 A
Resistance	contact: max. 0.1 Ω insulation: min. 10 ¹⁰ Ω
Capacitance	0.2 pF
Operate time / release time	max. 0.6 ms / max. 0.2 ms
Shock resistance	vibration: max. 30 G shock: max. 100 G
Changeover (CO) Type 07-2211-2*30	
Contact rating	max. 5 VA/W
Switching voltage	max. 175 V AC/DC
Switching current	max. 0.5 A
Resistance	contact: max. 0.1 Ω insulation: min. 10 ⁹ Ω
Capacitance	1.0 pF
Operate time / release time	max. 0.7 ms / max. 1.0 ms
Shock resistance	vibration: max. 4 G shock: max. 50 G

Safety Instructions

The proximity switch may be used only within the specified temperature class and the temperature range indicated for it (see type label).

The proximity switches is not suitable for use in Zone 0/20. The proximity switch ma be operated only i fit is clean and not damaged in any way. Unprotected, incorrect installation can cause malfunctioning and the loss of explosion protection. Utilization in areas other than those specified or the modification oft he product by anyone other than the manufacturer are not permitted and will exempt BARTEC from liability for defects and any further liability.

The generally applicable statutory rules and other binding directives relating to workplace safety, accident prevention and environmental protection must be observed.

When using electrical systems, the relevant installation and operating conditions must be observed. The specifications on the type label must be adhered to.

Observe the applicable laws and directives when commissioning or restarting operation. Always follow the safety instructions on the operating equipment.

Marking

Particularly important points in these instructions are marked with a symbol:

 **DANGER** indicates a hazardous situation which, if not avoided, will result in death or serious injury.

 **WARNING** indicates a hazardous situation which, if not avoided, could result in death or serious injury.

 **CAUTION** indicates a hazardous situation which, if not avoided, could result in minor or moderate injury.

 **ATTENTION** is used to address practices not related to personal injury.

 **NOTE** Important instructions and information on effective, economical and environmentally compatible handling.

Standards conformed to

Please see the Attestation of Conformity.

Selection chart

Type	Contact form	Cable length	Core	Core colour	Ambient temperature range
285557	normally open	5 m (16.4 ft)	2 x 0.5 mm ² tinned ends	blue and brown	-40 °C to +55 °C (-40 °F to +131 °F)
301800	normally open	1.75 m (5.75 ft)	2 x 0.5 mm ² tinned ends	blue and brown	
277330	normally open	3 m (9.8 ft)	2 x 0.5 mm ² tinned ends	blue and brown	
246113	normally closed	3 m (9.8 ft)	2 x 0.34 mm ² crimp sockets	black and brown	-40 °C to +70 °C (-40 °F to +158 °F)
246111	normally closed	5 m (16.4 ft)	2 x 0.34 mm ² crimp sockets	black and brown	
246110	normally closed	4.3 m (14.1 ft)	2 x 0.34 mm ² crimp sockets	black and brown	
246104	normally closed	3.7 m (12,1 ft)	2 x 0.34 mm ² crimp sockets	black and brown	
246103	normally closed	1.5 m (4.9 ft)	2 x 0.34 mm ² crimp sockets	black and brown	

Complete order no.

0 7 - 2 2 1 1 - 2 * * *

A B B

A	Length of connection cable
1	1 m
3	3 m
5	5 m
0	please specify other length in plain text

BB	Contact type
10	Normally closed (NC)
20	Normally open (NO)
30	Changeover (CO)

Other types on request.

Transport, Storage



ATTENTION

Damage to the proximity switch through incorrect transport or incorrect storage.

- Transport and storage is permissible in original packaging only.

Assembly, installation and disassembly



ATTENTION

Property damage due to incorrect proceedings.

- Only authorized and qualified personnel may do any of the assembly, disassembly, installation and commissioning work.
- The proximity switches must be supplied from a circuit limiting the current to a maximum of 0.5 A depending upon the reed switch.
- Always disconnect the proximity switch from voltage before assembly / disassembly.
- Use only suitable tools.

Assembly/Disassembly

Check at the assembly:

- Mount the proximity switch on an even supporting surface.
- Mount the proximity switch that it is protected from light and impact.
- Mount the proximity switch that the permanently attached cables are suitably terminated and protected from impact.

Installation

During installation take care not to damage the individual wires in conductors. It depends on the proximity switch type if the cable ends have to be tinned or if crimp sockets have to be mounted on each wire (see page 3).

If crimp sockets are required:

- Strip the cable 50 mm (1.97 in).
- Crimp the crimp sockets AMP 170361-3 with suitable crimping tools.

Operation



ATTENTION

Property damage due to incorrect proceedings.

- The proximity switches must only be supplied from a circuit containing a disconnect device having a braking capacity of 1,500 A.
- The proximity switch may be operated only within the technical limits that apply to it (see page 1 and 4).

Maintenance and fault clearance



ATTENTION

Property damage due to incorrect proceedings.

- Only authorized and qualified personnel may do any of the maintenance work and fault clearance.

Maintenance work

The operator of the proximity switch must keep it in good condition, operate it correctly, monitor it and clean it regularly.

- Check sealings for effectiveness.
- Replace old or damaged sealings with new original seals.
- Check that the connecting terminals and cable and conductor entries are secure.

Fault clearance

The proximity switch is a sealed unit and there are no serviceable parts. If the proximity switch is defective, the complete unit has to be replaced considering this operational instruction.

Disposal

The components in the proximity switch contain metal and plastic parts.

The statutory requirements for disposing of electronic scrap must be observed therefore (e.g. disposal by an approved disposal company).

Accessories, spare parts and disposal

See BARTEC catalogue Control and connection equipment.

Dimensions in mm (in)

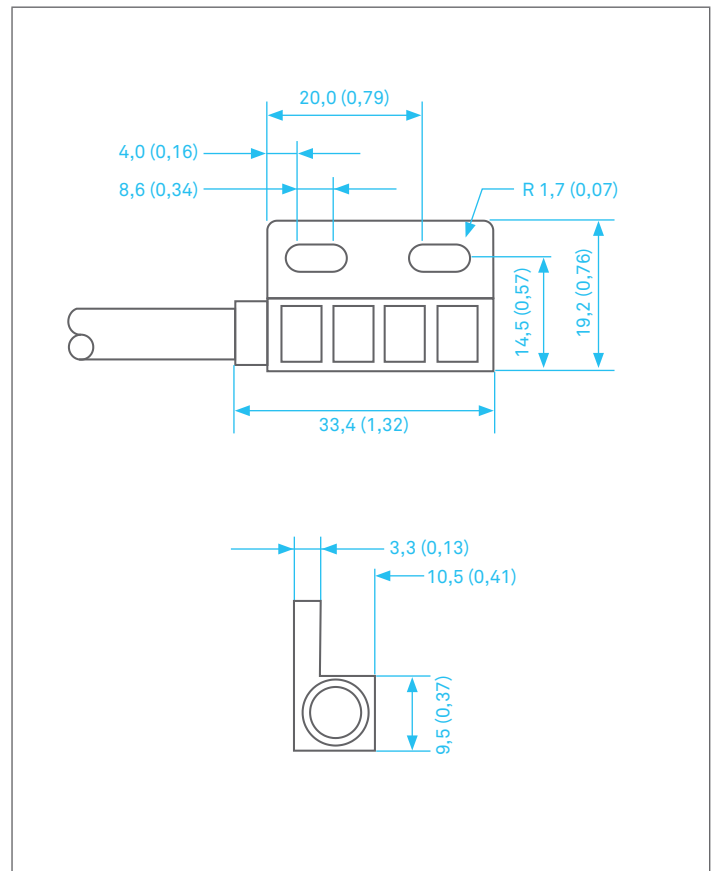

Cable end details

Tinned ends

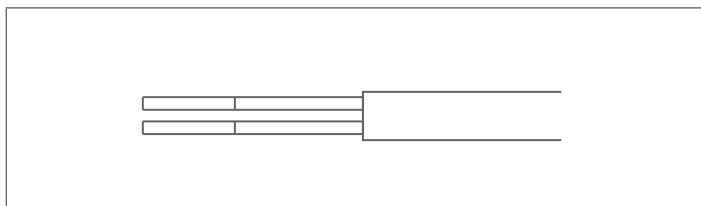

With crimp sockets AMP 170361-3

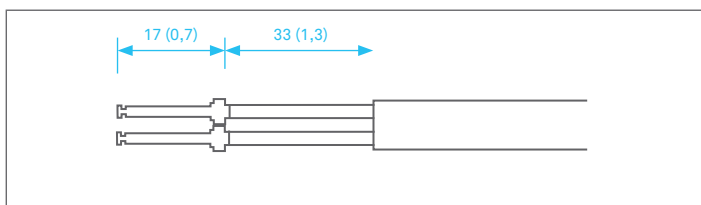

Service-Address

BARTEC GmbH
Max-Eyth-Str. 16
97980 Bad Mergentheim
Germany

Phone: +49 7931 597-0
info@bartec.com



EU Konformitätserklärung
 EU Declaration of Conformity
 Déclaration UE de conformité
 N° 01-2211-7C0001-C



Wir	We	Nous
-----	----	------

BARTEC GmbH
 Max-Eyth-Straße 16
 97980 Bad Mergentheim
 Germany

erklären in alleiniger Verantwortung, dass das Produkt Näherungsschalter	declare under our sole responsibility that the product Proximity Switch	attestons sous notre seule responsabilité que le produit Interrupteur de proximité
------------------------------------------------------------------------------------	-----------------------------------------------------------------------------------	----------------------------------------------------------------------------------------------

Typ 07-*211-****

auf das sich diese Erklärung bezieht den Anforderungen der folgenden Richtlinien (RL) entspricht ATEX-Richtlinie 2014/34/EU RoHS-Richtlinie 2011/65/EU und mit folgenden Normen oder normativen Dokumenten übereinstimmt	to which this declaration relates is in accordance with the provision of the following directives (D) ATEX-Directive 2014/34/EU RoHS-Directive 2011/65/EU and is in conformity with the following standards or other normative documents	se référant à cette attestation correspond aux dispositions des directives (D) suivantes Directive ATEX 2014/34/UE Directive RoHS 2011/65/UE et est conforme aux normes ou documents normatifs ci-dessous
--------------------------------------------------------------------------------------------------------------------------------------------------------------------------------------------------------------------------------------------------------	------------------------------------------------------------------------------------------------------------------------------------------------------------------------------------------------------------------------------------------------------------------------	-----------------------------------------------------------------------------------------------------------------------------------------------------------------------------------------------------------------------------------------

EN IEC 60079-0:2018

EN 60079-18:2015+A1:2017

Verfahren der EU-Baumusterprüfung / Benannte Stelle	Procedure of EU-Type Examination / Notified Body	Procédure d'examen UE de type / Organisme Notifié
------------------------------------------------------------	---------------------------------------------------------	----------------------------------------------------------

Baseefa05ATEX0159X – Issue 3

0598, SGS FIMKO OY, Takomotie 8, 00380 HELSINKI, FI



Bad Mergentheim, 16.12.2022

i.A. Simon Dyhringer
 i.A. Simon Dyhringer
 Product Manager Ex e

S. Mika
 i.A. Steffen Mika
 Certification Manager R&D

BARTEC

BARTEC GmbH
Max-Eyth-Str. 16
97980 Bad Mergentheim
Germany

Tel.: +49 7931 597-0
info@bartec.com

bartec.com