

Scan module for Pixavi Phone

Quick Start Guide



Quick Start Guide - Translation

Scan module

for Pixavi Phone

Type 17-A1Z0-0001/0003****

ATEX/IECEX/UKEX Zone 1/21

NEC Class I Division 1/Zone 0

Document No.: 11-S1Z0-7E0002

Status: September 2023 / Revision B

Proviso: Subject to technical changes. Changes, mistakes and printing errors do not substantiate any claim to damages.

Content	Pages
English	1-44

1	Basic safety information	1
1.1	Information on this Quick Start Guide	1
1.1.1	Languages	3
1.1.2	Changes in the document	3
1.2	Handling the product	3
1.3	Intended use	4
1.3.1	Exclusive purpose	4
1.3.2	Unintended use	4
1.4	Duties of the operator	4
1.5	Safety information	4
1.6	Maintenance	5
1.6.1	Servicing	5
1.6.2	Inspection	5
1.6.3	Repairs	5
1.6.4	Commissioning	5
1.7	Labelling, test certificate, and standards	5
1.8	Warranty	6
1.9	Co-applicable documents	7
2	Regulatory information	8
2.1	Health and Safety Recommendations	8
2.1.1	Ergonomic Recommendations	8
2.2	Batteries	9
2.2.1	Battery information	9
2.2.2	Battery Safety Guidelines	10
2.3	Devices with Laser and LED/ <i>Appareils avec laser et LED</i>	12
2.3.1	Laser Devices/ <i>Appareils laser</i>	12
2.3.2	LED Devices/ <i>Appareils à LED</i>	12
3	Product description	13
3.1	Scan module	13
3.2	Purpose of use	13
4	Structure	14
5	Technical data	17
5.1	Explosion protection	17
5.2	Features	18
5.2.1	Physical features	18
5.2.2	User environment	18
5.2.3	Barcode capture	18
5.3	Battery	19
5.4	Product labelling	20
6	Transport and storage	22
6.1	Transport	22
6.2	Storage	22

7	Commissioning	23
7.1	Requirements in hazardous areas.....	24
7.2	Getting started.....	25
7.2.1	Insert/change Scan module.....	25
7.3	Check/update the operating system.....	28
7.3.1	Checking the operating system (build number).....	28
7.3.2	Updating the operating system.....	29
7.4	Charging the Scan Module/battery.....	31
7.5	Using the Scan module.....	32
7.6	Scan handle (optional).....	33
8	Operation	34
8.1	Configuring the Scan module.....	34
8.1.1	123 Scan Utility.....	34
8.1.2	Create configuration.....	34
8.1.3	Transferring the configuration to the scan module.....	36
8.1.4	Set custom default values.....	37
8.2	Reset the scan module.....	38
8.2.1	Default settings.....	38
8.2.2	Factory settings.....	38
8.3	Scanning - Barcode.....	39
8.3.1	Scanning.....	39
9	Disposal	40
10	Declaration of Conformity	41
10.1	EU Declaration of Conformity.....	41
10.2	UK Declaration of Conformity.....	42
11	Notes	43

1 Basic safety information

1.1 Information on this Quick Start Guide



Read carefully before putting the devices into operation.

The Quick Start Guide is a fixed part of the product. It must be kept in the direct vicinity of the device and the installation, operating and service staff must have access to it at all times.

The Quick Start Guide contains important information, safety instructions and test certificates which are necessary for the perfect function of the device in operation.

The Quick Start Guide is directed at all individuals concerned with the commissioning, handling and servicing of the product. The applicable guidelines and standards for areas with gas and dust atmosphere (EN/IEC 60079-17, EN/IEC 60079-19) must be observed when conducting this work.

Knowledge of the safety and warning information in this Quick Start Guide and the strict compliance with it is essential for safe installation and commissioning. Accidents, injuries and material damage can be avoided by circumspect handling and systematically following the instructions.

The examples, tables, and figures provided in this Quick Start Guide are for illustration purposes. Due to the different requirements of the respective application, the BARTEC company cannot assume responsibility or liability for actual use based on the examples and figures.

The BARTEC company reserves the right to carry out technical changes at any time.

In no event will BARTEC company be responsible or liable for indirect or consequential damages resulting from the use or application of this Quick Start Guide.

Safety and warning information is particularly emphasised in this Quick Start Guide and marked by symbols.

 DANGER/DANGER

DANGER describes a directly imminent danger. If not avoided, death or severe injury will be the consequence.

DANGER décrit un danger directement imminent. Si cela n'est pas évité, la mort ou des blessures graves en seront les conséquences.

 WARNING/AVERTISSEMENT

WARNING describes a possibly imminent danger. If not avoided, death or severe injury may be the consequence.

AVERTISSEMENT décrit un danger potentiellement imminent. Si cela n'est pas évité, la mort ou des blessures graves peuvent en résulter.

 CAUTION/PRUDENCE

CAUTION describes a possibly imminent danger. If not avoided, mild or slight injury may be the consequence.

PRUDENCE décrit un danger éventuellement imminent. Si cela n'est pas évité, des blessures légères ou légères peuvent en résulter.

ATTENTION/ATTENTION

ATTENTION describes a possibly damaging situation. If not avoided, the plant or objects in its vicinity may be damaged.

ATTENTION décrit une situation potentiellement dommageable. Si cela n'est pas évité, l'installation ou les objets à proximité peuvent être endommagés.



Important information on effective, economical & environmentally compliant handling.

1.1.1 Languages

The original Quick Start Guide with safety information is written in German. All other available languages are translations of the original Quick Start Guide.

The Quick Start Guide is available in German and English. If further languages are required, these must be requested from BARTEC or stated on placing an order.

1.1.2 Changes in the document

BARTEC reserves the right to change the content of this document without notification. No warranty is assumed for the correctness of the information. In cases of doubt, the German safety instructions apply because it is not possible to rule out errors of translation or printing. In the case of legal disputes, the "General Terms and Conditions of Business" of the BARTEC Group also apply.

The current versions of the datasheets, user manual, certificates and declarations of conformity can be downloaded from www.bartec.com or may be requested directly from BARTEC GmbH.

1.2 Handling the product

The product described in this Quick Start Guide left the factory in a perfect and tested state in terms of safety. To maintain this state and to achieve a perfect and safe operation of this product, it may only be operated in the manner described by the manufacturer. In addition, the perfect and safe operation of this product requires correct transportation, proper storage and careful operation.

The safe and perfect handling of the Scan module is a prerequisite for its perfect and correct functioning.

1.3 Intended use

1.3.1 Exclusive purpose

The Scan module series is a handheld piece of electrical equipment. It serves the purpose of the mobile recording, processing and/or radio transmission of data within hazardous areas.

It is used exclusively in combination with devices which comply with the requirements placed on the overvoltage category I.

The admissible operating data of the device used must be considered.

1.3.2 Unintended use

Any other use is unintended and may lead to damage and accidents. The manufacturer shall not be liable for any use extending beyond the exclusive purpose.

1.4 Duties of the operator

The operator undertakes to only permit persons to work with the Scan module who

- are acquainted with the basic regulations on safety and accident prevention, and who have been inducted in the use of the Scan module,
- have read and understood the documentation, the safety chapter and the warnings.

The operator checks that the safety and accident prevention regulations applicable to the respective case of use have been observed.

1.5 Safety information

- Do not dry wipe or clean devices in hazardous areas!
- Do not open devices in hazardous areas.
- Do not replace or charge battery in hazardous areas.
- General statutory provisions or guidelines on occupational health and safety, accident prevention provisions and environmental protection laws must be heeded, e.g. Operational Safety Ordinance (BetrSichV) and nationally applicable ordinances.
- Use suitable clothing and shoes with respect to the danger of hazardous electrostatic charges.
- Avoid heat influences outside the specified temperature range.
- Protect device from external influences! Do not expose device to caustic/aggressive liquids, vapours or spray. In the case of malfunction or damaged enclosure, remove the device immediately from the hazardous area and bring it to a safe place.

1.6 Maintenance

The pertinent erection and operating provisions for electrical systems must be observed! (e.g. Directive 2014/34/EU, BetrSichV and nationally applicable ordinances EN/IEC 60079-14 and the series DIN VDE 0100)!

Observe the national waste disposal regulations when disposing of the devices.

1.6.1 Servicing

No constant servicing will be necessary if operated correctly under consideration of the assembly instructions and environmental conditions.

1.6.2 Inspection

According to EN/IEC 60079-17 and EN/IEC 60079-19 the operator of electrical systems in hazardous areas is obliged to have these inspected by an electrician to ensure correct condition.

1.6.3 Repairs

Repairs to explosion-protected devices may only be performed by authorized personnel with original spare parts and according to the state of the art.

Therefore all repairs to the Scan modul have to conducted by BARTEC.

Contact information and instructions for repair requests and processing can be found at:

<https://bartec.com/service-support/returns-repair>

Select "Automation and Enterprise Mobility"

- Procedure guide
- RMA Form

1.6.4 Commissioning

It must be checked that all components and documents are available before commissioning.

1.7 Labelling, test certificate, and standards

Labels on explosion protection and the test certificate are attached to the Scan module. Labelling see Chapter: Technical data.

The guidelines and standards applicable to the Scan modul for devices and protected systems for intended use in hazardous areas are provided in Chapter: Declaration of Conformity.

1.8 Warranty

WARNING/AVERTISSEMENT

No changes or retrofits may be made without the written consent of the manufacturer.

If non-specified components are used, the explosion protection will no longer be guaranteed. In the case of externally procured parts, it is not guaranteed that these have been designed and manufactured in accordance with their load and requisite safety.

- ▶ Contact the manufacturer before any changes or retrofits to receive a release. Only use original spare and wearing parts.

Aucune modification ou rénovation ne peut être effectuée sans le consentement écrit du fabricant.

Si des composants non spécifiés sont utilisés, la protection contre les explosions n'est plus garantie. Dans le cas de pièces achetées en externe, il n'est pas garanti qu'elles aient été conçues et fabriquées conformément à leur charge et à la sécurité requise.

- ▶ *Contactez le fabricant avant toute modification ou mise à niveau pour recevoir une version. Utilisez uniquement des pièces de rechange et d'usure d'origine.*



The manufacturer shall exclusively assume the complete warranty only for spare parts ordered from him.

Our “General Terms and Conditions of Sale and Delivery” shall apply in principle. These shall be made available to the operator on signing of contract at the latest. Warranty and liability claims in the case of injury and damage to property shall be excluded if they are attributable to one or several of the following causes:

- Unintended use of the Scan module.
- Incorrect handling
- Failure to observe the information in the Quick Start Guide and the user manual with respect to transport, storage, commissioning, operation and service.
- Independent structural changes
- Faulty monitoring of parts subject to wear and tear.
- Incorrectly performed repairs.
- Cases of disaster through the impact of foreign bodies and force majeure.

In accordance with our General Terms and Conditions for Deliveries and Services, we grant a warranty period of one year starting from the date of transfer of risk. This warranty covers all parts of the delivery and shall be restricted to the free replacement or repair of the defective parts in our Bad Mergentheim factory. For this purpose, any packaging supplied must be kept where possible. In the case of warranty, the goods must be returned to us after written agreement using an RMA form. There shall be no claim to repair at the sight of erection.

This Quick Start Guide contains all important information on the subject of explosion protection.

Further product information on handling and commissioning can be found on the BARTEC support page: <https://automation.bartec.de/indexE.htm>

1.9 Co-applicable documents

Document	Explanation
Quick Start Guide Pixavi Phone	This Quick Start Guide describes the safety-related information, first use and further data of the Pixavi Phone.
Data sheet Pixavi Phone	This technical data sheet contains the most important explosion-relevant technical data as well as general technical data of the Pixavi Phone.
Data sheet Scan module	This technical data sheet contains the most important explosion-relevant technical data as well as general technical data of the Scan module.

2 Regulatory information

All BARTEC devices are designed to be compliant with the rules and regulations in locations they are sold and will be labeled as required.

Any changes or modifications to BARTEC equipment, not expressly approved by BARTEC, could void the user's authority to operate the equipment.

CAUTION/PRUDENCE

Only use BARTEC approved and UL Listed accessories, batteries, base stations and charging stations. DO NOT charge the Pixavi Phone or batteries when they are damp or wet. All components must be dry before connecting to an external power source.

Utilisez uniquement des accessoires, des batteries, des stations de base et des stations de charge approuvés par BARTEC et homologués UL. NE PAS charger le téléphone Pixavi ou les batteries lorsqu'ils sont humides ou mouillés. Tous les composants doivent être secs avant de les connecter à une source d'alimentation externe.

2.1 Health and Safety Recommendations

2.1.1 Ergonomic Recommendations

CAUTION/PRUDENCE

In order to avoid or minimize the potential risk of ergonomic injury follow the recommendations below. Consult with your local Health & Safety Manager to ensure that you are adhering to your company's safety programs to prevent employee injury.

Afin d'éviter ou de minimiser le risque potentiel de blessure ergonomique, suivez les recommandations ci-dessous. Consultez votre responsable local de la santé et de la sécurité pour vous assurer que vous respectez les programmes de sécurité de votre entreprise afin de prévenir les blessures des employés.

- Reduce or eliminate repetitive motion
- Maintain a natural position
- Reduce or eliminate excessive force
- Keep objects that are used frequently within easy reach
- Perform tasks at correct heights
- Reduce or eliminate vibration
- Reduce or eliminate direct pressure
- Provide adjustable workstations
- Provide adequate clearance
- Provide a suitable working environment
- Improve work procedures

2.2 Batteries

2.2.1 Battery information

CAUTION/PRUDENCE

Risk of explosion if battery is replaced by an incorrect type.

Dispose of batteries according to instructions. Use only BARTEC approved batteries.

Accessories which have battery charging capability are approved for use with the following battery models:

Battery – Type 17-S1Z0-0001 (3.8 V / 3200 mAh)

Scan module – Type 17-S1Z0-0001/0003**** (3.8 V / 3200 mAh)

Risque d'explosion si la batterie est remplacée par un type incorrect.

Éliminez les piles conformément aux instructions. N'utilisez que des batteries approuvées par BARTEC.

Les accessoires dotés d'une capacité de chargement de la batterie sont approuvés pour les modèles de batterie suivants :

Batterie – Type 17-S1Z0-0001 (3.8 V / 3200 mAh)

*Module de scanning – Type 17-S1Z0-0001/0003**** (3.8 V / 3200 mAh)*

BARTEC approved rechargeable batteries are designed and constructed to the highest standards within the industry.

However, there are limitations to how long a battery can operate or be stored before needing replacement. Many factors affect the actual life cycle of a battery pack, such as heat, cold, harsh environmental conditions and severe drops.

When batteries are stored over six (6) months, some irreversible deterioration in overall battery quality may occur. Store batteries at half of full charge in a dry, cool place, removed from the equipment to prevent loss of capacity, rusting of metallic parts and electrolyte leakage.

When storing batteries for 6 months or longer, the charge level should be verified at least once in 3 months and charged to half of full charge.

Replace the battery when a significant loss of run time is detected.

2.2.2 Battery Safety Guidelines

**IMPORTANT – SAFETY INSTRUCTIONS – SAVE THESE INSTRUCTIONS****⚠ WARNING/AVERTISSEMENT**

When using this product basic safety precautions should always be followed, including the following:

The area in which the units are charged should be clear of debris and combustible materials or chemicals. Particular care should be taken where the device is charged in a non-commercial environment.

- Read all the instructions before using the product.
- Follow battery usage, storage, and charging guidelines found in the Quick Start Guide.
- Improper battery use may result in a fire, explosion, or other hazard.

Lors de l'utilisation de ce produit, il convient de toujours respecter les mesures de sécurité de base, notamment les suivantes :

La zone dans laquelle les appareils sont chargés doit être exempte de débris et de matériaux combustibles ou de produits chimiques. Il convient d'être particulièrement vigilant lorsque l'appareil est chargé dans un environnement non commercial.

- *Lisez toutes les instructions avant d'utiliser le produit.*
- *Respectez les consignes d'utilisation, de stockage et de chargement des batteries figurant dans le guide de démarrage rapide.*
- *L'utilisation incorrecte de la batterie peut entraîner un incendie, une explosion ou d'autres risques.*

- To charge the mobile device battery, the battery and charger temperatures must be between 0°C and +45°C (+32°F and +113°F).
- Do not use incompatible batteries and chargers. Use of an incompatible battery or charger may present a risk of fire, explosion, leakage, or other hazard. If you have any questions about the compatibility of a battery or a charger, contact Bartec support.
- Do not disassemble or open, crush, bend or deform, puncture, or shred. Damaged or modified batteries may exhibit unpredictable behavior resulting in fire, explosion, or risk of injury.
- Severe impact from dropping any battery-operated device on a hard surface could cause the battery to overheat.
- Do not short circuit a battery or allow metallic or conductive objects to contact the battery terminals.
- Do not modify, disassemble, or remanufacture, attempt to insert foreign objects into the battery, immerse or expose to water, seawater, rain, snow or other liquids, or expose to fire, explosion, or other hazard.
- Do not leave or store the equipment in or near areas that might get very hot, such as in a parked vehicle or near a radiator or other heat source. Do not place battery into a microwave oven, pressure cooker or dryer.
- To reduce the risk of injury, close supervision is necessary when used near children.
- Please follow local regulations to promptly dispose of used re-chargeable batteries.
- Do not dispose of batteries in fire. Exposure to temperatures over 100°C (212°F) may cause explosion.
- Seek medical advice immediately if a battery has been swallowed.
- In the event of a battery leak, do not allow the liquid to come in contact with the skin or eyes. If contact has been made, wash the affected area with large amounts of water and seek medical advice.
- If you suspect damage to your equipment or battery, contact Bartec support to arrange for inspection.

2.3 Devices with Laser and LED/*Appareils avec laser et LED*

2.3.1 Laser Devices/*Appareils laser*

Class 2 laser scanners use a low power, visible light diode. As with any very bright light source such as the sun, the user should avoid staring directly into the light beam.

Momentary exposure to a Class 2 laser is not known to be harmful.

Les scanners laser de classe 2 utilisent une diode à lumière visible de faible puissance. Comme pour toute source de lumière très brillante telle que le soleil, l'utilisateur doit éviter de regarder directement le faisceau lumineux.

L'exposition momentanée à un laser de classe 2 n'est pas connue pour être nocive.

CAUTION/AVERTISSEMENT

Use of controls, adjustments, or the performance of procedures other than those specified in the supplied product documentation may result in hazardous laser light exposure.

L'utilisation de commandes, de réglages ou l'exécution de procédures autres que celles spécifiées dans la documentation du produit fournie peuvent entraîner une exposition dangereuse à la lumière laser.

SE5500

- Wavelength/*Longueur d'onde*: 520 nm
- Max. output of laser radiation/*Max. sortie du rayonnement laser*: 1.63 mW (peak)
- Pulse Duration/*Durée d'impulsion*: 3.82 ms

2.3.2 LED Devices/*Appareils à LED*

Classified as 'EXEMPT RISK GROUP' according to IEC 62471:2006 and EN 62471:2008.

Pulse Duration of CW for SE5500

Classé comme « GROUPE DE RISQUE EXEMPT » selon les normes CEI 62471:2006 et EN 62471:2008.

Durée d'impulsion de CW pour SE5500

3 Product description

3.1 Scan module

The Pixavi Phone brings best-in-class technical specifications into the toughest environments with confidence and style. Highly ruggedized, yet elegant and sleek, the intrinsically safe Android Pixavi Phone guarantees safety, reliability, and top performance. Simply put, it is the safe choice for high performance in hazardous areas.

With the additional Scan module, with integrated Zebra Scan Engine and a range of up to 14 m, you can read a variety of 1D and 2D barcodes to streamline everyday business processes.



3.2 Purpose of use

Pixavi Phone with Scan module is a handheld electrical devices. Intended use is the entry, processing and (radio) transmission of data within hazardous areas.

Pixavi Phone with scan module complies with the requirements for overvoltage category I and may be used exclusively in combination with equipment that complies with the requirements for overvoltage category I.

The **Scan module, Type 17-S1Z0-0001/0003****** has been certified for use in the following hazardous areas:

ATEX/IECEX/UKEX Zone 1/21

NEC Class I Division1/Zone 0

4 Structure

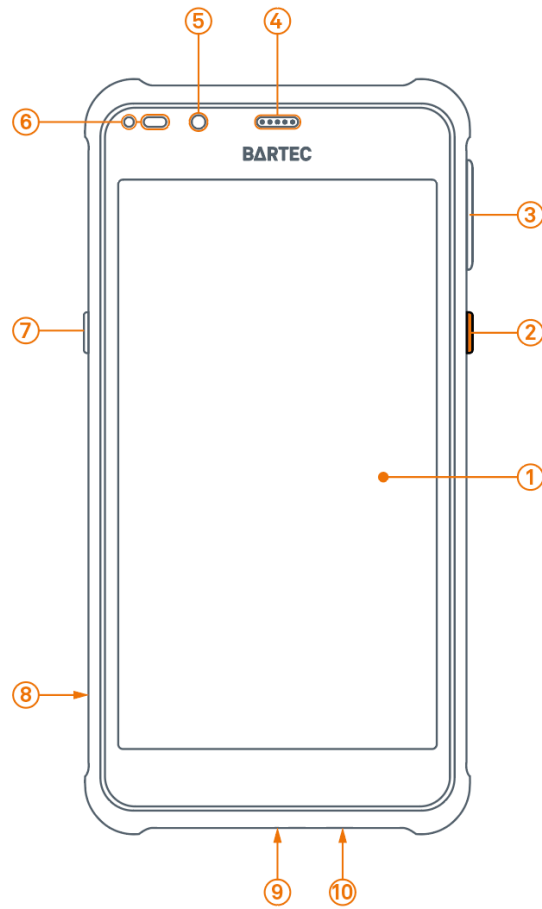

1	Touch Screen	Displays all information needed to operate the device.
2	Power Button	Turns the display on and off. Press and hold to turn the device on or off.
3	Volume Button	Increase and decrease audio volume.
4	Speaker	Provides audio output for video and music playback. Provides audio in speakerphone mode.
5	Camera	Use to take photos and videos.
6	Proximity Sensor/ Light Sensor	Determines proximity for turning off display when in handset mode. Determines ambient light for controlling display backlight intensity.
	Charging/Notification LED	Indicates battery charging status while charging and app generated notifications.
7	Scan Button	Initiates data capture (programmable).
8	Hand strap Mounting Point	Provides latching point for the hand strap.
9	Magnetic Charging Contacts	Provides power to the device from charging cable.
10	Microphone	Use for communications in Handset mode.

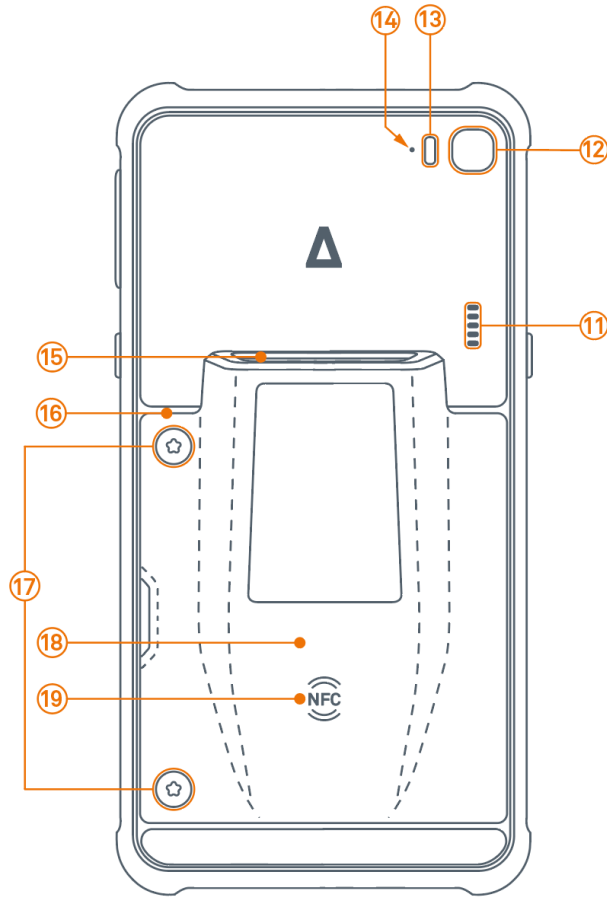

11	Speaker	Provides audio output for video and music playback. Provides audio in speakerphone mode.
12	Camera	Use to take photos and videos.
13	Camera Flash	Provides illumination for the camera.
14	Microphone	Use during video recording and for noise cancellation.
15	Scan Window	Provides data capture using the imager.
16	MicroSD + Nano SIM card holder	Card holder for 1x MicroSD card + 1x Nano-SIM card or 2x Nano-SIM cards. Located underneath the Scan modul.
17	Screws (captive)	Fix the scan module in the device.
18	Scan module (with battery)	Contains the scanner and provides power to the device.
19	NFC antenna	Enables communication with other NFC-enabled devices.

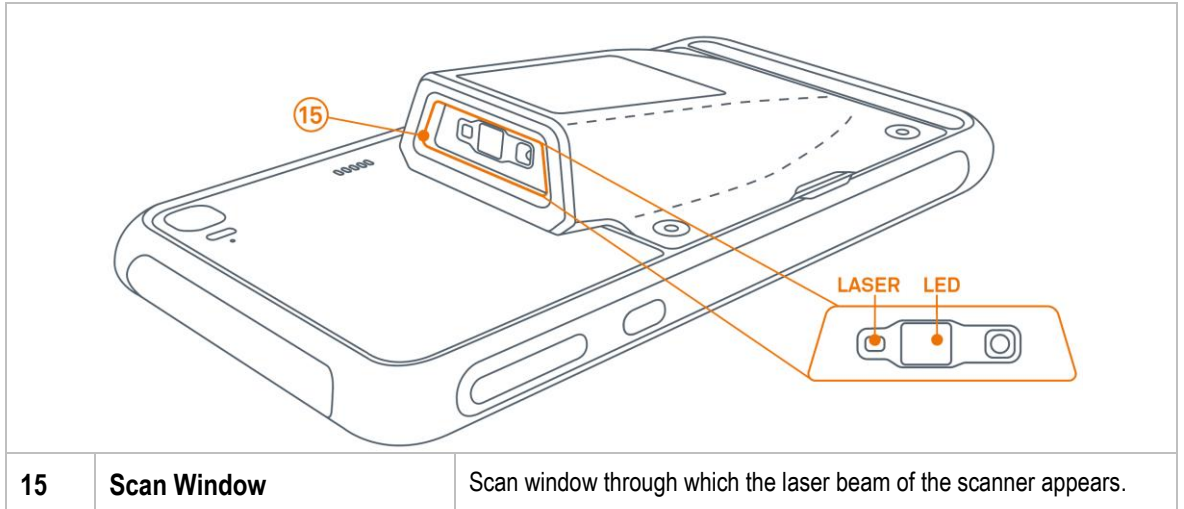

5 Technical data

5.1 Explosion protection

ATEX Zone 1 / 21	
Type	17-S1Z0-0001/0003 Scan module
Labelling	Ⓔ II 2G Ex ib op is IIC T4 Gb Ⓔ II 2D Ex ib op is IIIC T135°C Db IP68 -20 °C ≤ Ta ≤ +60 °C
Test certificate	CSANe 23ATEX1078X
Standards	see: EU Declaration of Conformity
IECEX Zone 1 / 21	
Type	17-S1Z0-0001/0003 Scan module
Labelling	Ex ib op is IIC T4 Gb Ex ib op is IIIC T135°C Db IP68 -20 °C ≤ Ta ≤ +60 °C
Test certificate	IECEX CSAE 23.0015X
Standards	see: EU Declaration of Conformity
UKEX Zone 1 / 21	
Type	17-S1Z0-0001/0003 Scan module
Labelling	Ⓔ II 2G Ex ib op is IIC T4 Gb Ⓔ II 2D Ex ib op is IIIC T135°C Db IP68 -20 °C ≤ Ta ≤ +60 °C
Test certificate	CSAE 23UKEX1064X
Standards	see: UK Declaration of Conformity
NEC500/505	
Type	17-S1Z0-0001/000300NA Scan module
Labelling	Class I; Divison 1; Groups A, B, C and D; T4 Ex ia op is IIC T4 Ga Class I, Zone 0, AEx ia op is IIC T4 Ga
Test certificate USA and Canada	CSA 23CA80141535X

Specific conditions of use:

The apparatus shall only be fitted to a Ex certified Pixavi Thermal, Pixavi Phone and Pixavi Cam (17-S13*-****/*****).

The apparatus shall not be subjected to a prolific charge generating mechanism (such as might occur in pneumatic transfer of powders or charge spraying in a powder coating process).

5.2 Features

5.2.1 Physical features

Dimensions: (Length x Width x Height)	94 x 75 x 29,5 mm (3.7 x 2.95 x 1.16 inch)
Weight	approx. 130 g (0.29 lb)

5.2.2 User environment

Operating temperature	-20 °C to +60 °C (-4 °F to +140 °F)
Storage temperature	-20 °C to +50 °C (-4 °F to +122 °F)
Charging temperature	0 °C to +45 °C (+32°F to +113°F)
Relative humidity	5 % to 90 % (non-condensing)
Class of protection (IEC 60529)	IP 68

5.2.3 Barcode capture

1D-/2D Barcodes	
SE55	1D/2D High performance scanner omnidirectional; Reading range up to 14 m depending on type, size and quality of the barcode



The scanner used comply with LED devices in accordance with IEC 62471:2006 and EN 62471:2008.

Pulse Duration of CW for SE5500

SE55 supports following Symbologies/Barcodes:

Barcode Class	Symbology/Barcode
1D Barcodes	Chinese 2 of 5, Codabar, Code 11, Code 32, Code 39 (Trioptic), Code 93, Code 128, GS1-128, ISBT 128, Discrete 2 of 5, GS1 DataBar variants, Interleaved 2 of 5, Korean 3 of 5, Matrix 2 of 5, MSI, UPC/EAN code family (UPC-A; UPC-E, EAN-13/JAN13; EAN-8/JAN8; Bookland EAN, UCC Coupon Code)
2D Barcodes	Aztec, Composite Codes (CC-C; CC-A/B; TLC-39), DotCode, Data Matrix, GS1-Data Matrix, Gridmatrix, Han Xin, Maxicode, PDF417, MicroPDF417, QR Code, Micro QR Code, GS1-QR Code
Postal Codes	US Postnet, US Planet, UK Postal, Japan Postal, Australian Postal, USPS 4CB/One Code/Intelligent Mail, Netherlands KIX, UPU FICS, Mailmark

SE55 reading range:

The table below lists the typical distances for selected bar code densities. The minimum element width (or “symbol density”) is the width in mils of the narrowest element (bar or space) in the symbol.

Reading ranges are dependent on printing resolution, contrast, and ambient light.

Symbol Density/ Barcode Type	Typical Working Ranges	
	Near	Far
3 mil Code 39	6.9 cm (2.7 in.)	41.1 cm (16.2 in.)
5 mil Code 39	6.4 cm (2.5 in.)	67.6 cm (26.6 in.)
5 mil PDF417	7.1 cm (2.8 in.)	49.8 cm (19.6 in.)
6.7 mil PDF417	6.6 cm (2.6 in.)	65.0 cm (25.6 in.)
10 mil DataMatrix	5.6 cm (2.2 in.)	68.8 cm (27.1 in.)
100 % UPC (13 mil)	6.4 cm (2.5 in.)	180 cm (71 in.)
15 mil Code 128	18.2 cm * (7.2 in.)	182.9 cm (72.0 in.)
20 mil Code 39	- *	276.9 cm (109 in.)
55 mil Code 39	- *	744.2 cm (293 in.)
100 mil Code 39	- *	1407.2 cm (554 in.)
100 mil DataMatrix	- *	685.8 cm (270 in.)

* Limited by width of bar code in field of view.

5.3 Battery









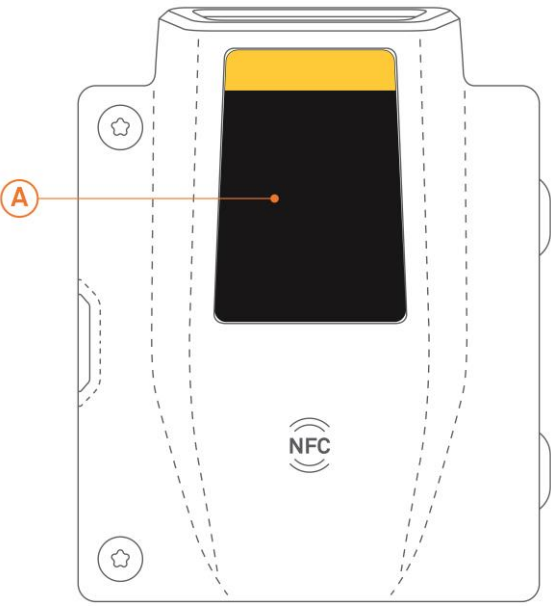

The life of the battery will depend on different use factors and the device settings, e.g.:

- Use and setting of WLAN/Bluetooth
- Background lighting/screensaver
- Use and setting of scanner

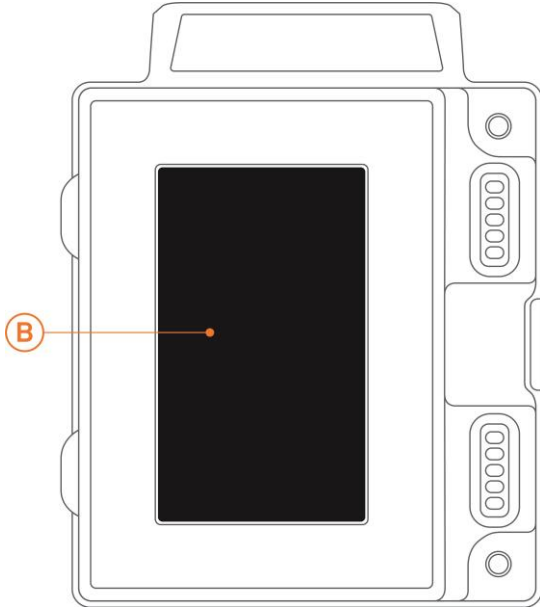
Battery	(only change and charge in the safe area) Lithium ion battery 3.8 V / 3200 mAh (12.16 Wh)
Operating temperature	
▪ During charging	0 °C to +45 °C (+32 °F to 113 °F)
▪ During discharging	-20 °C to +60 °C (4 °F to 140 °F)
Storage temperature	-20 °C to +50 °C (-4 °F to +122 °F)
Charging times	approx. 3 hours (from fully depleted to 90%)
UN38.3 compliant	Yes

5.4 Product labelling

		
	<p>Type label (Type 17-S1Z0-0001/0003)</p>	

		
	<p>Type label (Type 17-S1Z0-0001/0003)</p>	<p>Pixavi Battery - Scan Module Type: 17-S1Z0-0001/0003 Mfr: BARTEC GmbH Max-Eyth-Straße 16/97980 Bad Mergentheim, DE Factory ID: 80682 Battery info 3.8 V , 3200 mAh , 12.16 Wh Limited Charge Voltage (4.35 V) IP68</p> <p>CAUTION Only use with type: 17-S13*-1***/***** Do not disassemble, short circuit or dispose of in fire! Dispose of used batteries properly!</p> <p>ATTENTION Utiliser seulement avec le type: 17-S13*-1***/***** Ne pas démonter, ne pas court-circuiter ou jeter au feu! Éliminer les piles utilisées correctement!</p> <p>IEC: 1ICP6/54/78</p> <p> 0044  Secondary Li-ion battery</p> <p> SN: X8K23PB500071 MFD: SEPTEMBER 2023 Made in Germany</p> 

6 Transport and storage

6.1 Transport



Report any transport damage or incomplete deliveries immediately after receipt in writing to the forwarding company and BARTEC GmbH.

Any damage caused through incorrect storage shall not be covered by the warranty provisions of BARTEC GmbH.



Battery is UN38.3 conform.

Due to the transport guidelines for airfreight, all batteries are delivered ex works charged to max. 30 %.

Further information, like MSDS, can be found at
<http://automation.bartec.de/indexE.htm>

6.2 Storage

ATTENTION/ATTENTION

Property damage through incorrect storage!

- ▶ Observe storage temperatures.
- ▶ Keep humidity away from the Scan module.

Dommages matériels en cas de stockage incorrect!

- ▶ *Respectez les températures de stockage.*
- ▶ *Tenir l'humidité à l'écart du module de scanning.*

Additional information on the batteries

The batteries of BARTEC (Type Typ 17-A1Z0-0001/*****) are developed and manufactured in accordance with the highest industrial standards. The operating time or storage period of a battery is restricted, however. The actual life of a battery is influenced by different factors, e.g. hot, cold, rough operating environment and falling from a great height. If a battery is kept longer than six months, the performance may be impaired on a permanent basis. Keep the batteries in a dry, cool place. For longer periods of storage, remove the batteries from the device to prevent self-discharge, rusting of the metallic and the escape of electrolyte.

When storing batteries for 6 months or longer, the charge level should be verified at least once in 3 months and charged to half of full charge.

If electrolyte has escaped, do not touch the areas affected and dispose of the batteries as prescribed. Replace the battery if the operating time has shortened considerably.

7 Commissioning

DANGER/DANGER

Avoid electrostatic charging in hazardous areas.

Danger to life in explosive atmosphere!

- ▶ Do not dry wipe or clean the devices.
- ▶ Wear suitable clothing and shoes.
- ▶ Do not use rubber gloves or similar.

Évitez les charges électrostatiques dans les zones dangereuses.

Danger de mort dans une atmosphère explosive!

- ▶ *Ne pas essuyer ou nettoyer les appareils à sec.*
- ▶ *Portez des vêtements et des chaussures adaptés.*
- ▶ *Ne pas utiliser de gants en caoutchouc ou similaires.*

DANGER/DANGER

Unintended use endangers explosion protection.

Danger to life in explosive atmosphere!

- ▶ Do not make any changes to the Scan module.
- ▶ In the case of function disturbances or damage to the enclosure, the device should be removed immediately from the hazardous area to a safe place. Remove battery to decommission the device!

Une utilisation non conforme met en danger la protection contre les explosions.

Danger de mort dans une atmosphère explosive!

- ▶ *N'apportez aucune modification au module de scanning.*
- ▶ *En cas de perturbations fonctionnelles ou d'endommagement du boîtier, l'appareil doit être immédiatement retiré de la zone dangereuse et placé en lieu sûr. Retirer la batterie pour mettre l'appareil hors service !*

7.1 Requirements in hazardous areas

- The Scan-module and the battery may not be opened.
- Do not use, swap or replace any non-specified components.
- Protect the Scan-module from impact!
- Do not expose the Scan-module to caustic/aggressive liquids, vapours, mists!
- Avoid the impact of moisture outside the specifications.
- Avoid thermal impact outside the specified temperature range.
- Only charge the battery outside the hazardous area, using the chargers specified by BARTEC.
- To charge the battery, the battery and charging temperatures must be between 0°C and 45°C (32°F and 113°F).
- There is a danger of burning if used incorrectly. Do not expose the battery to temperatures of more than +60 °C (+140 °F).
- Defective batteries must be disposed of immediately, whereby the provisions on battery disposal applicable in the respective region must be observed.
- The battery may explode if it catches fire!
- Do not short circuit the battery!

Accessories

- Only install or replace accessories outside the hazardous area.
- User accessories exclusively which have been tested or certified by BARTEC for this purpose.

7.2 Getting started

7.2.1 Insert/change Scan module

Insert Scan module - work steps:

1. The Scan module (Type 17-S1Z0-0001/0003****) may only be inserted/changed/charged outside the hazardous area.
2. Use only Scan modules or batteries which have been tested or certified by BARTEC for this purpose.
3. Insert the scan module, right side first, into the battery compartment on the back of the device. Press the Scan module down into the battery compartment.

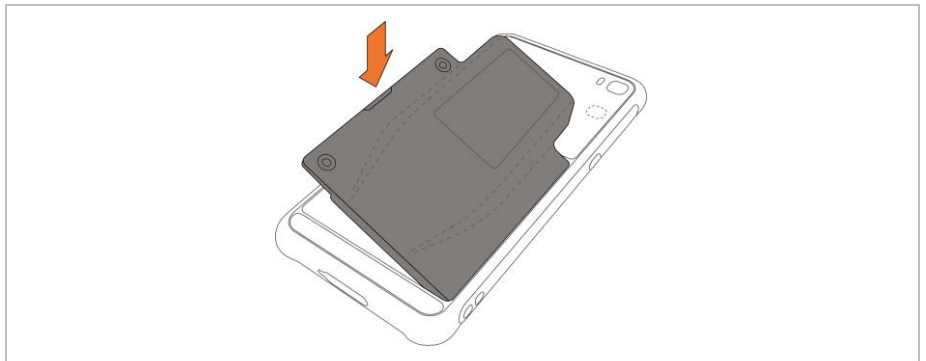

4. Screw the scan module tightly with the supplied battery tool.



Change battery - work steps:

ATTENTION/ATTENTION**Incorrect handling may cause damage to property!**

- ▶ Use only Scan modules or batteries which have been tested or certified by BARTEC for this purpose.
- ▶ Switch off the Pixavi Phone with the "Power Off" function before removing the battery. Errors when removing the battery can result in data loss.
The device does not have a hot-swap battery exchange function.

Une manipulation incorrecte peut entraîner des dommages matériels!

- ▶ N'utilisez que des module de scanning ou des batteries qui ont été testés ou certifiés par BARTEC pour cet usage.
- ▶ Eteignez le téléphone Pixavi avec la fonction "Power Off" avant de retirer la batterie. Des erreurs lors du retrait de la batterie peuvent entraîner la perte de données.

L'appareil n'a pas de fonction de remplacement à chaud de la batterie.

1. Remove any accessory attached to the device. (e.g. Scan handle)
2. Press the Power button until the menu appears.
3. Touch Power off.

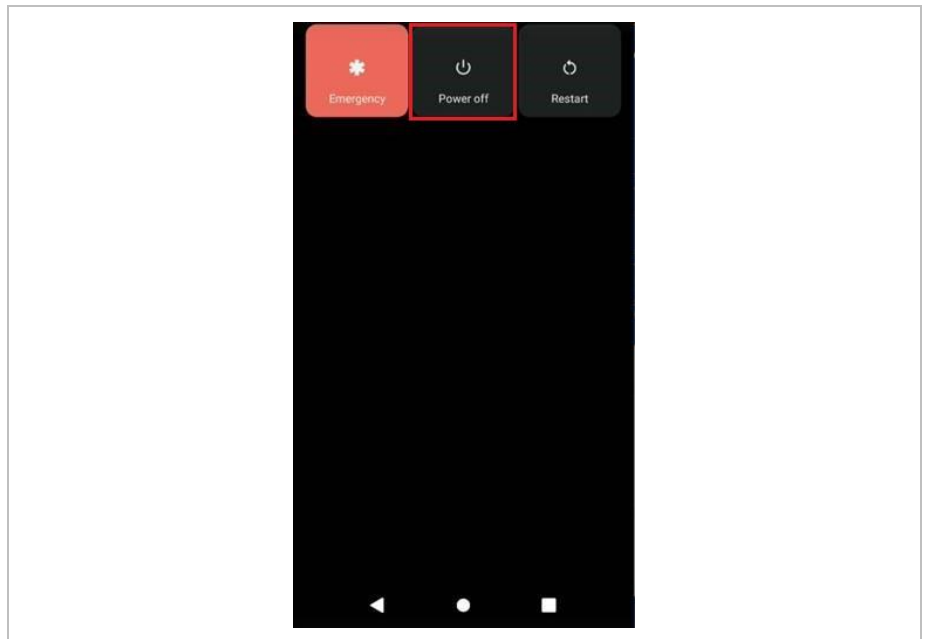

4. Wait until the device is switched off. (LED indicator goes off).

5. Loosen the two screws of the battery (or Scan module) with the supplied battery tool.

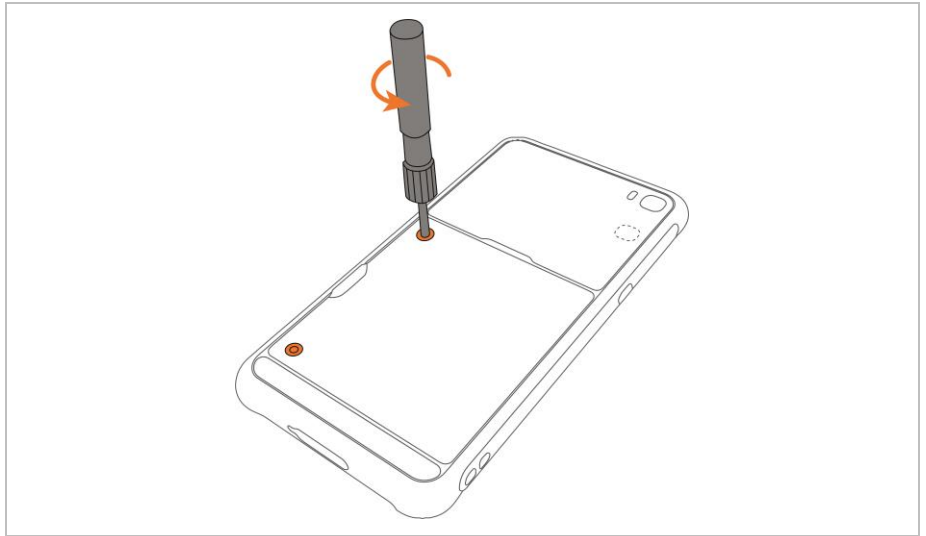

The screws are captive and cannot be removed completely!

6. Remove the battery (or scan module) from the device.

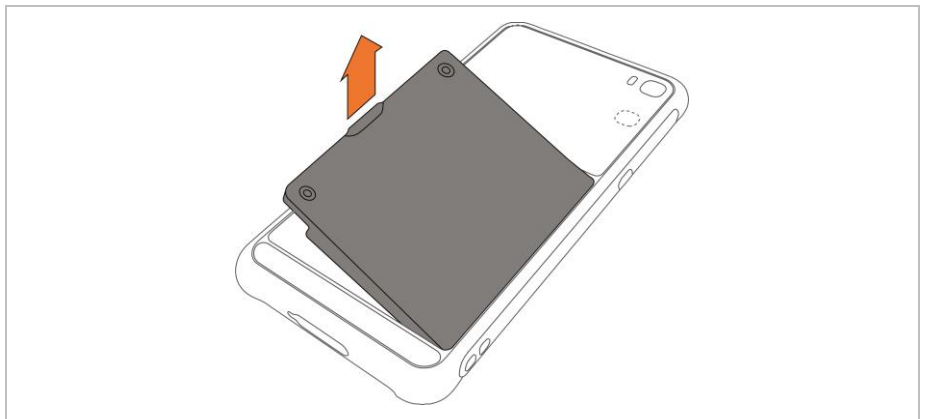

7. Insert the scan module, right side first, into the battery compartment on the back of the device. Press the Scan module down into the battery compartment and screw the scan module tightly with the supplied battery tool.

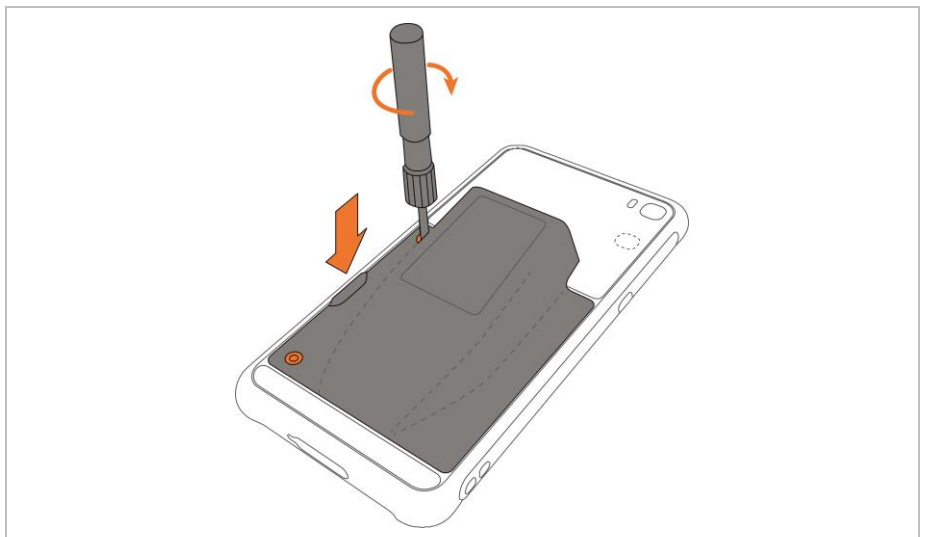

8. Press and hold the Power button to turn on the device.

7.3 Check/update the operating system

Before using the Scan module, check if the operating system supports the scan module.

7.3.1 Checking the operating system (build number)

1. Open the "Settings" in the menu.

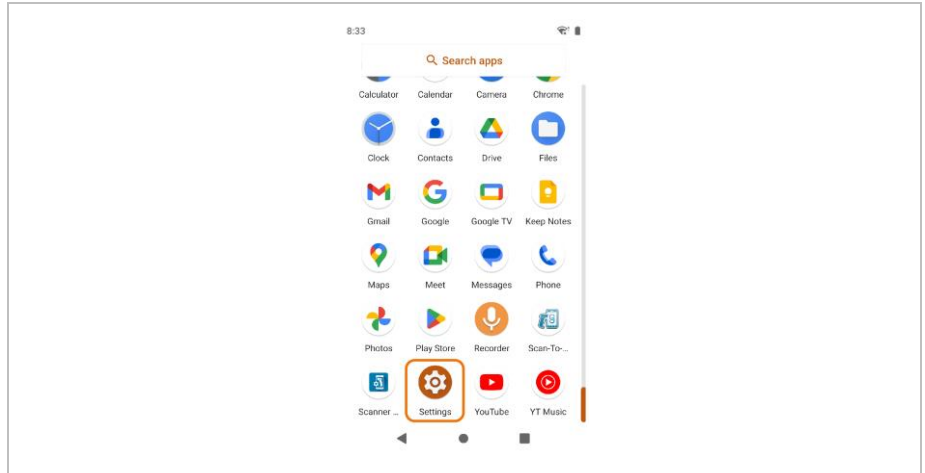

2. Scroll down and select the "About phone" menu.

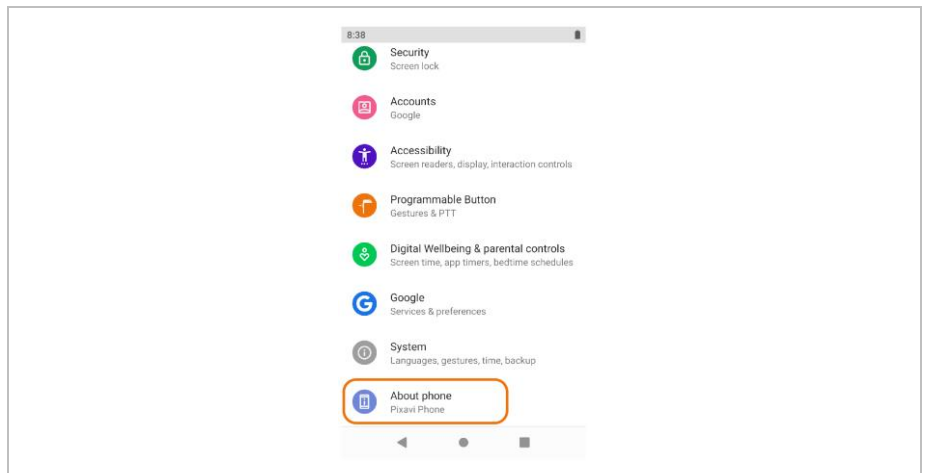

3. Scroll down to the "Build Number".
The build number must be at least version RWG1.230419.188 or a later date.
(date are the numbers in the middle: ****.YYMMDD.***; e.g. ****.230419.***)

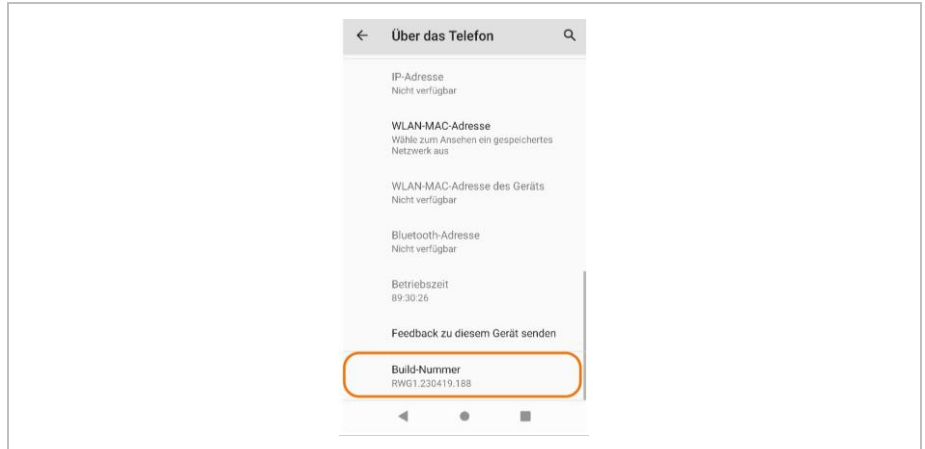

If the current build number/date is smaller, then the Pixavi Phone must be updated.
Requirement is an internet connection to be able to check for updates.

7.3.2 Updating the operating system

1. Open the "Settings" in the menu.

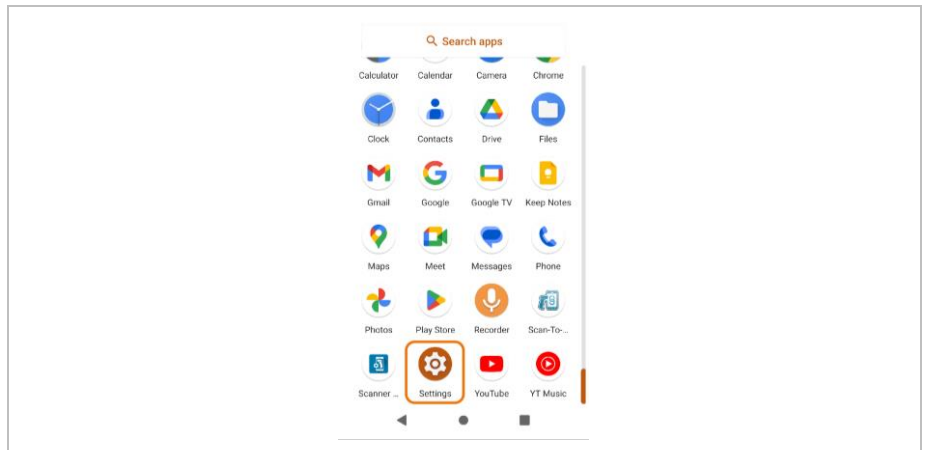

2. Scroll down and select the "System" menu.

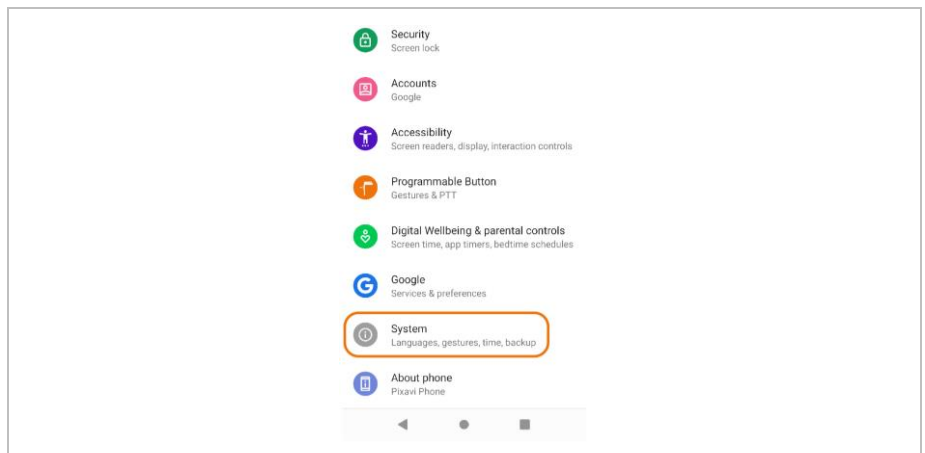

3. Open the "Advanced" menu.

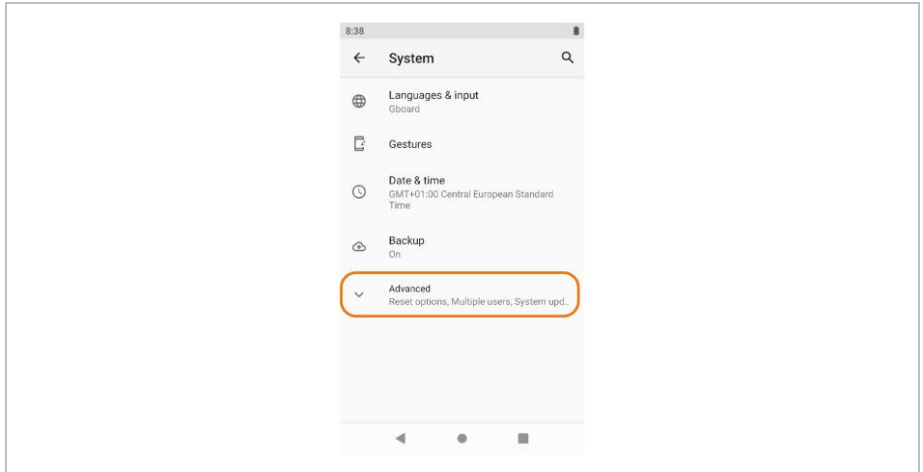

4. Select "System updates".

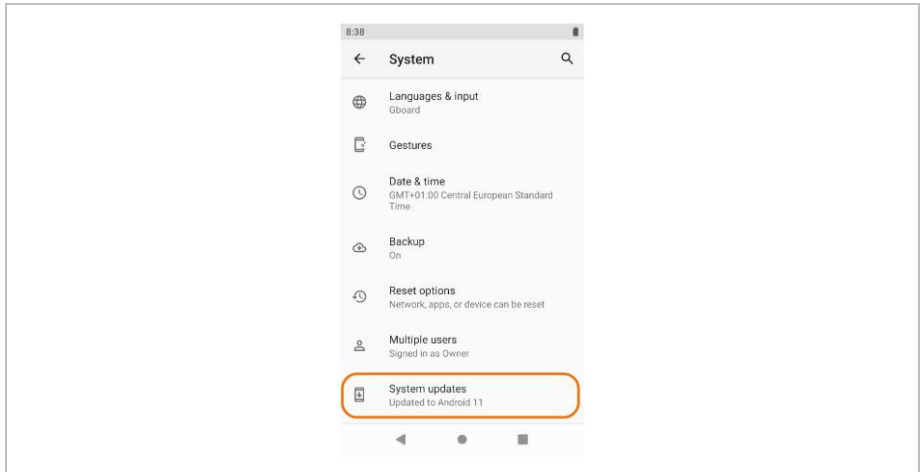

5. If an Internet connection is available, the system checks whether updates are available.

If updates are available, they can be installed.

If there is no Internet connection, an error message will appear telling you that it is not possible to check for available updates.

Operating system is up to date	New update available for installation	No internet connection to check for updates
<p>A screenshot of the system update screen with an orange header. It displays a circular refresh icon and the text 'No update available'. Below, it says 'No update is currently available for your device. You're running the latest build! RW01.230419.188'.</p>	<p>A screenshot of the system update screen with an orange header. It displays a circular refresh icon and the text 'New software available: 11188'. Below, it says 'An update is available for your device. The update will improve the security and stability of your BARTEC device.' At the bottom is a button labeled 'INSTALL UPDATE'.</p>	<p>A screenshot of the system update screen with a red header. It displays a white exclamation mark icon and the text 'Network error'. Below, it says 'Network Error: Unable to check in. Check that you are connected to the network.' At the bottom is a button labeled 'CHECK FOR UPDATES'.</p>

7.4 Charging the Scan Module/battery

Before using the device for the first time, charge the Scan module/battery until the Charging/Notification light emitting diode (LED) changes to solid green. To charge the device, use a cable or a cradle with the appropriate power supply.



In many cases, charging the battery to 90% provides plenty of charge for daily use.

DANGER/DANGER

Non certified accessories endanger explosion protection.

Danger to life exists in hazardous areas!

Les accessoires non certifiés compromettent la protection contre les explosions.

Dans les zones dangereuses, il y a danger de mort !

Only use accessories tested by BARTEC:

Charging Cable with type G7-S0Z0-0005



Charger - Version: EU with type G7-S0Z0-0001

Charger - Version: UK with type G7-S0Z0-0002

Charger - Version: US with type G7-S0Z0-0003

Charger - Version: AU with type G7-S0Z0-0004

1. Charge the Scan module/battery only outside hazardous areas.
2. Connect the Pixavi Phone with the Charging cable with the USB-C cable.

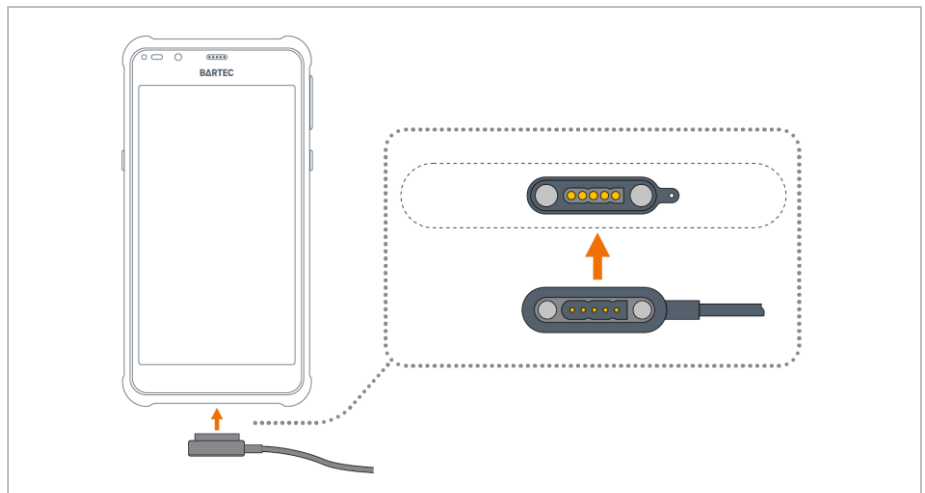

Do not use any force when inserting the magnetic charging/USB cable.

The cable can only be inserted in the orientation illustrated above.

3. Connect the Charging cable either directly to the USB port on the PC or with a USB adapter.
4. Ensure the device is connected properly. The Charging/Notification LED on the device lights up yellow to indicate that the device is charging.

7.4.1.1 Charging/Notifications-LED

The device's Charging/Notification LED indicates the status of the battery charging in the device.

The Battery charges in approximately 3 hours (from fully depleted to 90%).

State	Indication
Off	The battery is not charging.
Solid Red	The battery is charging, but is very low. (Charge level less than 5 %)
Solid Yellow	The battery is charging. (Charge level between 5 % and 89 %)
Solid Green	Charging complete. (Charge level above 90 %)

7.5 Using the Scan module

The Pixavi Phone automatically identifies when the scan module is installed.

The Scan button (left; programmable button) is automatically detected and programmed when the Scan module is mounted.

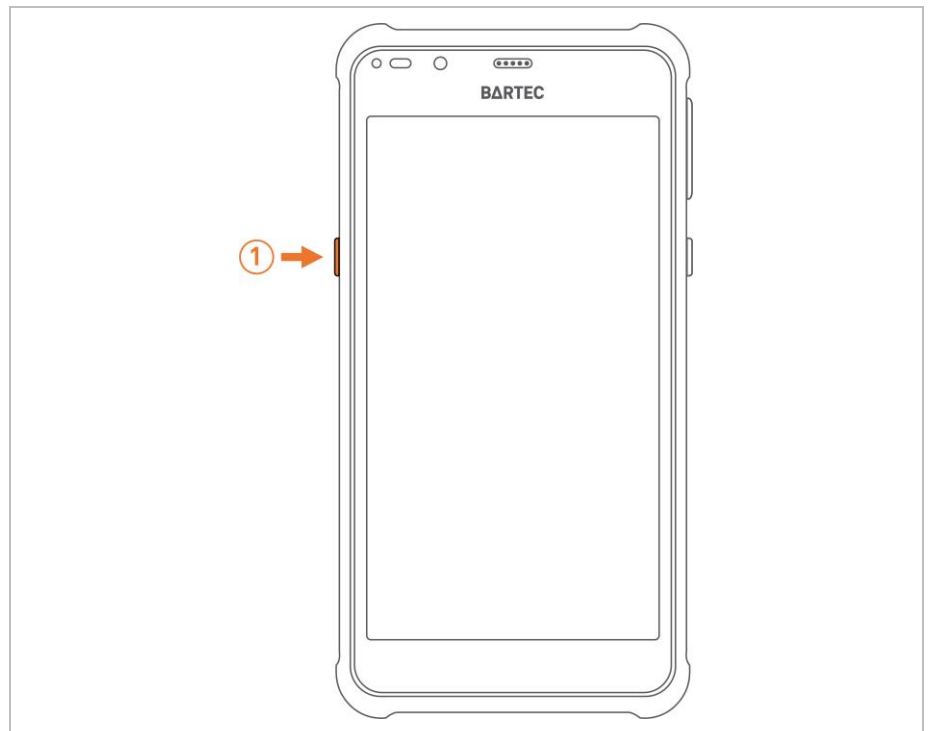

When the Scan module is mounted, it has priority over all other settings for the programmable key.

Exception: SOS function.

At this point, the Scan module is ready for use. For special configurations, see Chapter: Operation

7.6 Scan handle (optional)

The Scan handle adds a gun-style handle with a scanning trigger to the device. It increases comfort when using the device in scan-intensive applications for extended periods of time.

⚠ DANGER/DANGER

Non certified accessories endanger explosion protection.

Danger to life exists in hazardous areas!

▶ Only use the Scan handle from BARTEC with type 17-A1Z0-0016.

Les accessoires non certifiés compromettent la protection contre les explosions.

Dans les zones dangereuses, il y a danger de mort !

▶ Utilisez uniquement la poignée de scanning de BARTEC avec le type 17-A1Z0-0016.

To insert the device into the Scan handle:

1. Align and insert the top of the device into the front of the Scan handle.
2. Rotate the device down and press down until it snaps into place.



8 Operation

8.1 Configuring the Scan module

The scan module consists of the following parts from Zebra:

- SE55 Advanced Range Scan Engine
- Decoder Board PL5000

The scan engine is controlled internally via the decoder board and can be configured using the 123 Scan Utility.

For more information on individual Zebra components, see:

- SE55 Advanced Range Scan Engine
<https://www.zebra.com/us/en/products/oem/oem-engines/oem-array-imager-scan-engines/se55.html>
- Decoder Board PL5000
<https://www.zebra.com/us/en/products/oem/oem-engines/oem-array-imager-scan-engines/pl5000.html>
- 123 Scan Utility
<https://www.zebra.com/us/en/products/software/scanning-systems/123scan.html>



8.1.1 123 Scan Utility

123 Scan Utility is a user-friendly, PC-based software tool that enables quick and easy setup of Zebra scanners and therefore also the Scan module for the Pixavi Phone.

123 Scan Utility is available for download for Windows (32-bit or 64-bit) for free from Zebra Technologies:



<https://www.zebra.com/us/en/products/software/scanning-systems/123scan.html>

On the site there is also more detailed documentation and help videos on the use and functions of 123 Scan Utility.

8.1.2 Create configuration

The configuration is done in offline mode because the Pixavi Phone with Scan module cannot be connected to the 123 Scan Utility via USB.



The configuration is printed as a programmable code (Word, PDF or paper printout) and transferred to the scan module by scanning it.

1. Open 123 Scan Utility.
2. Select "Create new configuration file" on the 123 Scan Utility home screen.



3. In the next menu, select the option "My scanner is NOT connected".

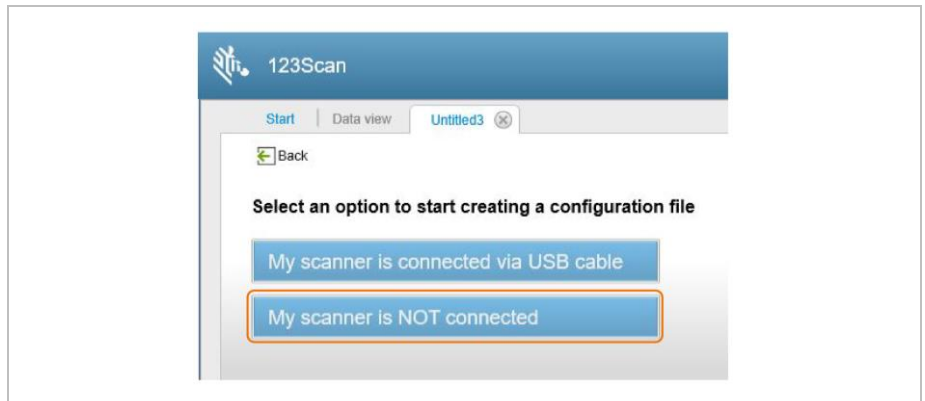

Pixavi Phone with scan module cannot be connected to 123 Scan Utility via USB.

4. Select the "PL5000" in the selection menu of the supported scanner models and decoder boards.

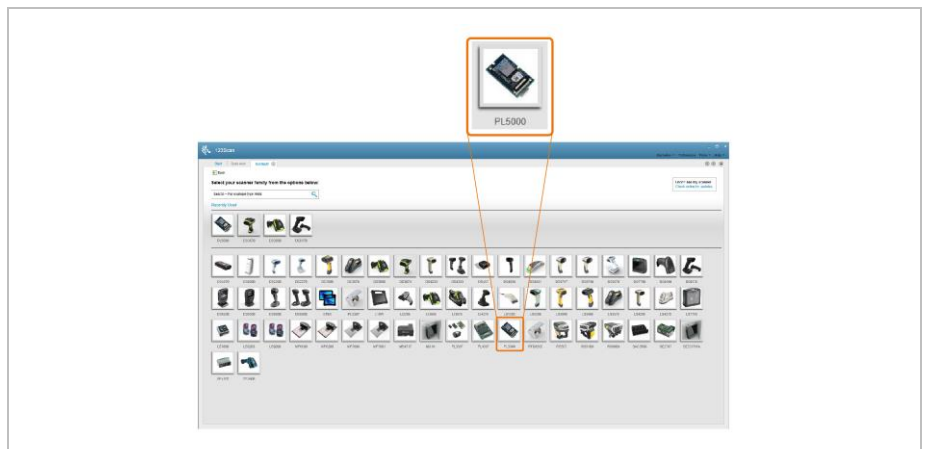

- In the following menu, select the "PL5000 - Common Models".

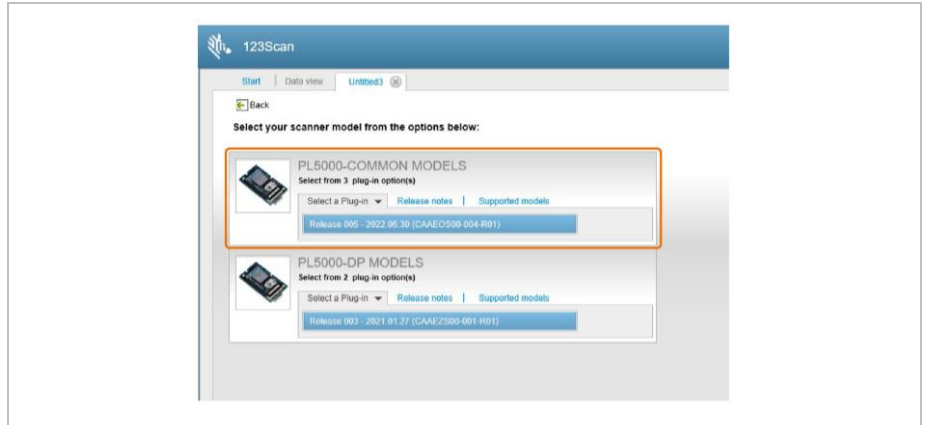

- Now you are in the menu to create the configuration for the scan module.

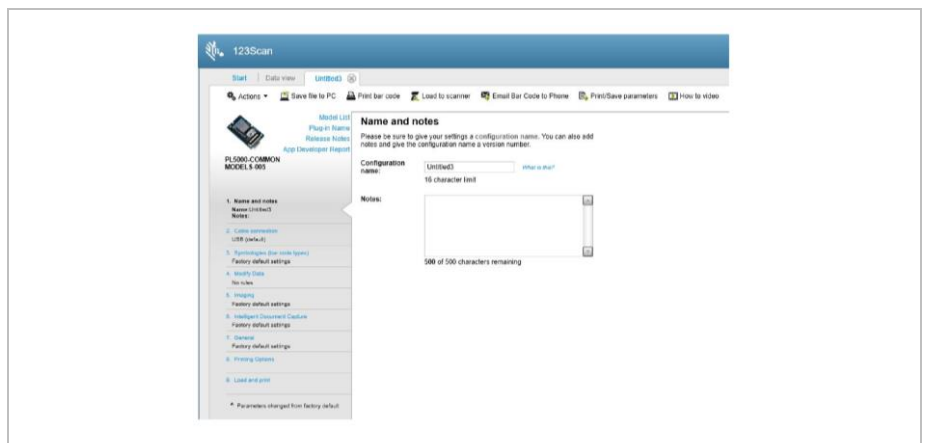

Further instructions with detailed explanations can be found on www.bartec.com oder <http://automation.bartec.de>

8.1.3 Transferring the configuration to the scan module

A configuration can only be transferred to the scan module by scanning the programmable codes.



Uploading the configuration as an electronic file via USB or an MDM/EMM system such as Soti, Airwatch or others is not supported.

- You can create programmable codes directly from the configuration menu. Select "Print bar code".



2. The configuration is displayed in the menu as a programmable code..

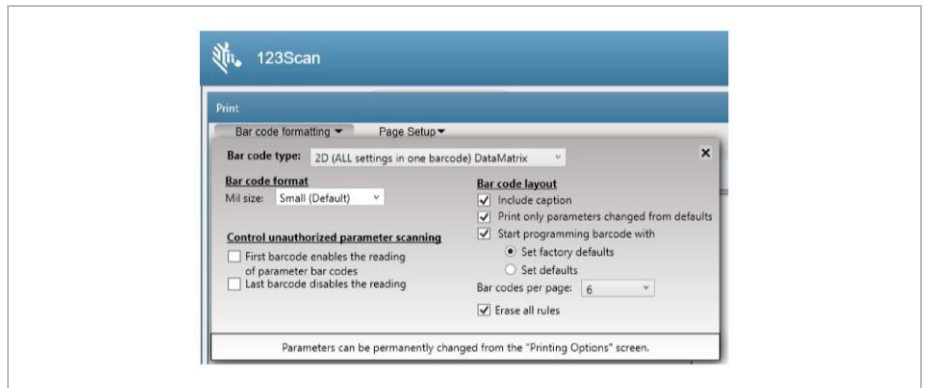

Depending on the scope of modifications you have made, the programming can consist of one or more barcodes.

You can freely customize the printout of the programmable codes

- ▶ Programmable code Type
- ▶ Size in "mil
- ▶ Barcode layout
- ▶ Programmable codes showing only the changed parameters or all parameters
- ▶ Start programming with or without "factory default" values
- ▶ Other settings

8.1.4 Set custom default values

To create a set of custom defaults, select the desired values in the 123 Scan Utility and then scan the "Write to Custom Defaults" barcode.



8.2 Reset the scan module

Scan one of the following barcodes to reset the decoder board to its default or factory settings.

8.2.1 Default settings

Scan Barcode for “*Restore Defaults*” resets default values as following:

- ▶ If you configured custom default parameter values via the “*Write to Custom Defaults*” barcode, scanning the “*Restore Defaults*” barcode restores these custom values.
- ▶ If you did not configure custom default parameter values, scanning the “*Restore Defaults*” barcode restores the factory default values.



8.2.2 Factory settings

Scan Barcode for “*Set Factory Defaults*” clears all user-defined defaults and sets the factory defaults.

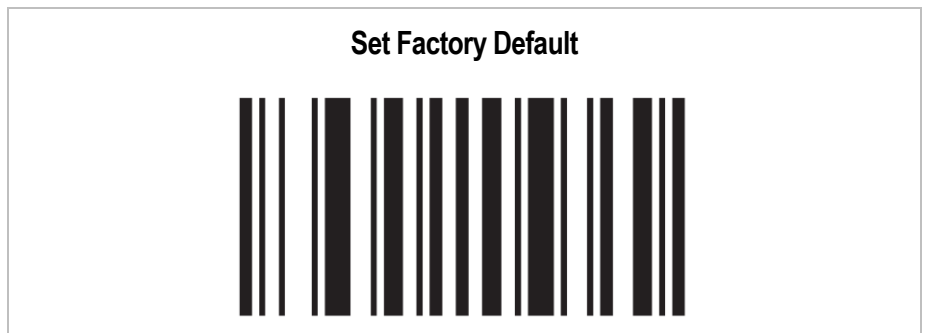

8.3 Scanning - Barcode

Use the 1D/2D imager to capture barcode data.

8.3.1 Scanning

1. Ensure that an application is open on the Pixavi Phone and a text field is in focus (text cursor in text field).
2. Point the top of the Pixavi Phone at a barcode.
3. Press and hold the Scan button.
The red laser aiming pattern turns on to assist in aiming.



NOTE: When the device is in "Picklist Mode", the device will not decode the barcode until the center of the crosshairs touches the barcode.

4. Ensure the barcode is within the area formed by the cross-hairs in the aiming pattern.
The aiming dot is used for increased visibility in bright lighting conditions.
5. A beep sounds, by default, to indicate the barcode was decoded successfully.
6. Release the scan button.



Note:

Decoding of the imager is normally instantaneous. The device repeats the steps required to make a digital image (Image) of a bad or difficult barcode as long as the scan button remains pressed.

The content data of the barcode is displayed in the text field.

Aiming Pattern – Default Settings



9 Disposal



Scan module and accessories contains metallic and plastic parts and electronic components.





WEEE registration number of the BARTEC GmbH:
DE 95940350





As professional electrical devices, our devices are intended exclusively for commercial use, so-called B2B devices, in accordance with the WEEE Directive. The WEEE Directive provides the framework for the treatment of old electrical equipment throughout Europe. This means that you may not dispose of these devices in usual household waste but must dispose of them separately in an environmentally compatible manner and can also bring them to the collection points of public disposal companies. All products purchased from us can be returned to us by our customers for disposal. We will ensure disposal in accordance with the applicable laws. The sender shall bear the costs of postage and packaging.

10 Declaration of Conformity

10.1 EU Declaration of Conformity

EU Konformitätserklärung EU Declaration of Conformity Déclaration UE de conformité N° 11-S130-7C0001-B		
Wir	We	Nous
BARTEC GmbH Max-Eyth-Straße 16 97980 Bad Mergentheim Germany		
erklären in alleiniger Verantwortung, dass das Produkt Pixavi Thermal / Pixavi Phone	declare under our sole responsibility that the product Pixavi Thermal / Pixavi Phone	attestons sous notre seule responsabilité que le produit Pixavi Thermique / Pixavi Phone
Typ 17-S13*-11*1/***** Accessories: Akku Typ 17-S1Z0-0001/0001 Scan Modul Typ 17-S1Z0-0001/0003		
auf das sich diese Erklärung bezieht den Anforderungen der folgen- den Richtlinien (RL) entspricht ATEX-Richtlinie 2014/34/EU RED-Richtlinie 2014/53/EU RoHS-Richtlinie 2011/65/EU WEEE-Richtlinie 2012/19/EU und mit folgenden Normen oder nor- mativen Dokumenten übereinstimmt	to which this declaration relates is in accordance with the provision of the following directives (D) ATEX-Directive 2014/34/EU RED-Directive 2014/53/EU RoHS-Directive 2011/65/EU WEEE-Directive 2012/19/EU and is in conformity with the following standards or other normative documents	se référant à cette attestation correspond aux dispositions des direc- tives (D) suivantes Directive ATEX 2014/34/UE Directive RED 2014/53/UE Directive RoHS 2011/65/UE Directive WEEE 2012/19/UE et est conforme aux normes ou docu- ments normatifs ci-dessous
EN IEC 60079-0:2018 EN 60079-11:2012 EN 60079-28:2015 EN IEC 62368-1:2020/A11:2020 EN 50360:2017 EN 50566:2017 EN 50663:2017 EN 62479:2010 EN 62209-1:2016 EN 62209-2:2010/A1:2019	EN 300 328 V2.2.2 EN 300 330 V2.1.1 EN 300 440 V2.2.1 EN 301 511 V12.5.1 EN 301 893 V2.1.1 EN 301 908-1 V13.1.1 EN 301 908-2 V13.1.1 EN 301 908-13 V13.1.1 EN 303 413 V1.2.1 EN 62133-2:2017	EN 301 489-1 V2.2.3 EN 301 489-3 V2.1.2 EN 301 489-17 V3.2.4 EN 301 489-19 V2.2.0 EN 301 489-52 V1.2.1 EN 55032:2015/A11:2020 EN 55035:2017/A11:2020 EN IEC 61000-3-2:2019/A1:2021 EN 61000-3-3:2013/A1:2019 EN 60825-1:2014 (Laser) EN 60825-1:2014/A11:2021(Laser) EN 62471:2008 (LED)
Verfahren der EU-Baumuster- prüfung / Benannte Stelle	Procedure of EU-Type Examination / Notified Body	Procédure d'examen UE de type / Or- ganisme Notifié
CSANe 20ATEX4223X 2813, CSA Group Netherlands B.V., Utrechtseweg 310, Building B42, 6812AR Arnhem, Netherlands		
 Bad Mergentheim, 08.05.2023		
 Andrej Sonkin 09.05.2023 11:14:46 [UTC+2] SVP Business Unit Enterprise Mobility	 Michael Krüger 09.05.2023 20:02:20 [UTC+2] VP Quality & Certification	
FB-0170e	Seite / page / page 1 von / of / de 1	

10.2 UK Declaration of Conformity

UK Declaration of Conformity		BARTEC
N ^o 11-S130-7CU001		
We		
BARTEC GmbH Max-Eyth-Straße 16 97980 Bad Mergentheim Germany		
declare under our sole responsibility that the product		
Pixavi Thermal / Pixavi Phone		
Type 17-S13*-11*1/*****		
Accessories: Akku Type 17-S1Z0-0001/0001		
Scan Modul Typ 17-S1Z0-0001/0003		
to which this declaration relates is in accordance with the provision of the following directives		
Statutory Instrument 2016 No. 1107 - The Equipment and Protective Systems Intended for Use in Potentially Explosive Atmospheres Regulations 2016		
Statutory Instrument 2017 No. 1206 - The Radio Equipment Regulations 2017		
Statutory Instrument 2012 No. 3032 - The Restriction of the Use of Certain Hazardous Substances in Electrical and Electronic Equipment Regulations 2012		
and is in conformity with the following standards or other normative documents		
EN IEC 60079-0:2018	EN 300 328 V2.2.2	EN 301 489-1 V2.2.3
EN 60079-11:2012	EN 300 330 V2.1.1	EN 301 489-3 V2.1.2
EN 60079-28:2015	EN 300 440 V2.2.1	EN 301 489-17 V3.2.4
EN IEC 62368-1:2020/A11:2020	EN 301 511 V12.5.1	EN 301 489-19 V2.2.0
EN 50360:2017	EN 301 893 V2.1.1	EN 301 489-52 V1.2.1
EN 50566:2017	EN 301 908-1 V13.1.1	EN 55032:2015/A11:2020
EN 50663:2017	EN 301 908-2 V13.1.1	EN 55035:2017/A11:2020
EN 62479:2010	EN 301 908-13 V13.1.1	EN IEC 61000-3-2:2019/A1:2021
EN 62209-1:2016	EN 303 413 V1.2.1	EN 61000-3-3:2013/A1:2019
EN 62209-2:2010/A1:2019	EN 62133-2:2017	EN 60825-1:2014 (Laser)
		EN 60825-1:2014/A11:2021(Laser)
		EN 62471:2008 (LED)
Procedure of internal control of production		
CSANe 20ATEX4223X		
2813, CSA Group Netherlands B.V., Utrechtseweg 310, Building B42, 6812AR Arnhem, Netherlands		
UK CA₂₅₀₃		
Bad Mergentheim, 2023-05-23		
		
Andrej Sonkin 24.05.2023 13:41:31 [UTC+2]	Michael Krüger 26.05.2023 07:58:07 [UTC+2]	
SVP Business Unit Enterprise Mobility	VP Quality & Certification	
FB-0413a	Page 1 of 1	

11 Notes

BARTEC

BARTEC GmbH
Max-Eyth-Str. 16
97980 Bad Mergentheim
Germany

Phone: +49 7931 597 0
info@bartec.com

bartec.com